



OPERATING INSTRUCTIONS

EN

Translation of the original instructions

ASM 340

Leak detector

PFEIFFER  **VACUUM**



Table of contents

1	About this manual	5
1.1	Validity	5
1.1.1	Applicable documents	5
1.2	Conventions	6
1.2.1	Safety instructions	6
1.2.2	Pictographs	7
1.2.3	Instructions/Abbreviations used	7
1.2.4	Labels	7
2	Safety	9
2.1	Safety precautions	9
2.2	Protective equipment	10
2.3	Proper use	11
2.4	Improper use	11
3	Transport and storage	12
3.1	Transport	12
3.2	Storage	13
4	Product description	14
4.1	Product identification	14
4.1.1	Scope of delivery	14
4.1.2	Variants	14
4.2	Interface connection	15
4.3	Test methods	15
4.3.1	Hard vacuum test	15
4.3.2	Sniffing test mode	16
5	Installation	17
5.1	Prerequisites for optimising measurement	17
5.2	Operating conditions	17
5.3	Set-up	17
5.3.1	Storing the lifting handles	17
5.3.2	Control panel equipment	18
5.4	Filling with oil (Wet model only)	18
5.5	Connecting the purge circuit	19
5.6	Connection to the mains power supply	20
5.7	Operating for the first time	20
5.7.1	Familiarise yourself with the control panel	20
5.7.2	Become familiar with the detector	20
5.8	Connecting the part/installation to be tested	21
5.9	Connecting the exhaust	21
5.10	Connection the primary pump (Integrable Model)	21
5.10.1	Characteristics of the primary pump	21
5.10.2	Connection of the primary pump	22
6	Operation	23
6.1	Control panel	23
6.1.1	Description	23
6.1.2	Contrast - Brightness - Screen Saver	24
6.1.3	Application screens	25
6.1.4	"Standard" screen	26
6.1.5	"Settings" screen	26
6.1.6	"Graph" screen	27
6.1.7	"Vacuum circuit" screen	27
6.1.8	"Measurement" window	27
6.1.9	Function keys	28
6.2	Prerequisites to use	28
6.3	Switching the detector on	28
6.3.1	Switch on	28
6.3.2	Starting a test	29



6.4	Monitoring operation	29
6.5	Shutdown the detector	29
6.6	Saving and downloading the product's configuration	30
6.6.1	Saving the configuration	30
6.6.2	Downloading the configuration	30
7	Advanced settings	31
7.1	"Graph" screen	31
7.1.1	Description	31
7.1.2	Settings	31
7.1.3	Recording	32
7.1.4	Erasing	32
7.1.5	Viewing a recording	33
7.1.6	Saving a recording	35
7.2	Settings	35
7.2.1	Tree diagram of the "Settings" menus	35
7.3	Set points Menu	42
7.3.1	Audio alarm and digital voice	43
7.3.2	Pollution function	43
7.3.3	Hard Vacuum reject point	43
7.3.4	Sniffing reject set point	44
7.3.5	Probe clogged set point	44
7.4	"Test" Menu	45
7.4.1	Test methods	45
7.4.2	Correction factor	46
7.4.3	Test mode	46
7.4.4	Type of probe	47
7.4.5	Automatic Cycle End	47
7.4.6	Inlet vent	47
7.4.7	Memo function	48
7.4.8	Zero activation	48
7.4.9	Bypass Option	49
7.4.10	Regeneration	49
7.4.11	Massive mode	50
7.5	Spectro Menu	50
7.5.1	Tracer gas	52
7.5.2	Filament parameters	52
7.5.3	Calibrated leak	52
7.6	Maintenance Menu	53
7.6.1	Detector	53
7.6.2	Timers	53
7.6.3	Detector Information	54
7.6.4	Pump Information	54
7.6.5	Event history	55
7.6.6	Calibration history	55
7.6.7	Burn-in	56
7.6.8	Maintenance for the analyzer cell and the secondary pump	56
7.7	Configuration Menu	56
7.7.1	Time - Date - Unit - Language	57
7.7.2	Function keys	57
7.7.3	Application screens	58
7.7.4	Screen Settings	60
7.7.5	Access - Password	60
7.8	Advanced Menu	63
7.8.1	Leak Detection Menu	63
7.8.2	Leak Detection: Start-up timer	63
7.8.3	Leak detection: Background suppression	63
7.8.4	Leak Detection: Crossover Pressures	64
7.8.5	Leak Detection: Calibration	64
7.8.6	Leak detection: Analyzer cell	65
7.8.7	Leak Detection: Internal Pirani gauge calibration	65
7.8.8	Leak Detection: External gauge	66
7.8.9	Leak Detection: Purge valve	66
7.8.10	Leak detection: Dynamic calibration	66
7.8.11	Input/Output menu	68
7.8.12	Input/Output: Serial Link 1 and Serial Link 2	68
7.8.13	Input/Output: I/O connector	69
7.8.14	SD Card menu	69
7.8.15	Service	70



8	Maintenance / replacement	71
	8.1 Maintenance intervals and responsibilities	71
9	Service	72
10	Accessories	73
11	Technical data and dimensions	74
	11.1 General	74
	11.2 Technical data	74
	11.3 Units of measurement	74
	11.4 Dimensions	75
	Declaration of conformity	76
	Declaration of incorporation of partly completed machinery	77



1 About this manual

1.1 Validity

This operating manual is for customers of Pfeiffer Vacuum. It describes the functioning of the designated product and provides the most important information for safe use of the unit. The description follows applicable EU guidelines. All information provided in this operating manual refers to the current state of the product's development. The documentation remains valid as long as the customer does not make any changes to the product.

Up-to-date operating instructions can also be downloaded from www.pfeiffer-vacuum.com.

This manual covers products with the following part numbers:

Part number	Description
JSVA00AxMx9x	ASM 340 Wet (all models)
KSBA00AxMM9A	ASM 340 Dry (all models)
MSXAOxAxMM9A	ASM 340 Integrable (all models)

1.1.1 Applicable documents

Documents relevant for the use of options and/or accessories, and for product maintenance are the following:

ASM 340	Operating instructions
Standard Remote Control Operating instructions	P/n 121774
RC 500 WL Remote Control Operating instructions	P/n IG0140B
RS-232 Operating instructions	P/n 121777*
Operating instructions for the 15 pin I/O board	P/n 121776*
Operating instructions for the 37 pin I/O board (Wi-Fi + Ethernet + USB)	P/n 123894*
Bluetooth Module Operating instructions	P/n 121778*
Compatibility Modul of E/S HLT Operating instructions	P/n 122864*
Profibus Operating instructions	P/n 123923*
Standard Sniffer Probe Operating instructions	P/n 121780*
Smart Sniffer Probe Operating instructions	P/n BG5268BE
Spray Gun Operating instructions	P/n 121781*
Bypass Operating instructions	P/n PL0002B
ASM 340 Maintenance instructions	P/n 121762M
Declaration of conformity	Included with this manual
Declaration of incorporation of partly completed machinery	Included with this manual

*also available at www.pfeiffer-vacuum.com

1.2 Conventions

1.2.1 Safety instructions

Operating manual safety instructions Pfeiffer Vacuum are based on the UL, CSA, ANSI Z-535, SEMI S2, ISO 3864 and DIN 4844 certification standards. This document describes the following information and danger levels:

DANGER
Imminent danger Indicates an imminent hazardous situation that will result in death or serious injury.
WARNING
Possibly imminent danger Indicates an imminent hazardous situation that can result in death or serious injury.
CAUTION
Possibly imminent danger Indicates an imminent hazardous situation that can result in minor or moderate injury.
NOTICE
Command or note Command to perform an action or information about properties, the disregarding of which may result in damage to the product.



1.2.2 Pictographs



Prohibition of an action to avoid any risk of accidents, the disregarding of which may result in serious accidents



Warning of a displayed source of danger in connection with operation of the unit or equipment



Command to perform an action or task associated with a source of danger, the disregarding of which may result in serious accidents

1.2.3 Instructions/Abbreviations used

⇒ or → Work instruction: you must perform an operation here.

[XXXX] You must press the XXXX key on the control panel.

I/O Inputs/Outputs



Example: press the "Home" key on the control panel to return to the «Standard» screen.

⁴He Helium 4

³He Helium 3

H₂ Hydrogen

1.2.4 Labels

This chapter lists all the labels that could appear on the product as well as their meaning.



Safety label: guarantee that the packing has not been opened since leaving the factory.



Indicates that the operator must:

- ⇒ handle the product using the devices shown on this label,
- ⇒ comply with the rules for moving the equipment, taking weight and dimensions into account.

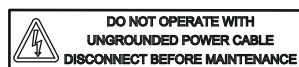

Indicates an electric shock hazard in case of contact:

- ⇒ do not use the product if the power cable is not earthed,
- ⇒ disconnect the electrical power supply before working on the product.



Indicates an electrical shock hazard in case of contact:

- ⇒ disconnect the electrical power supply before removing the cover and working on the product.



Locate a grounding point on the product.



Customization label for the product according to the customer's request.

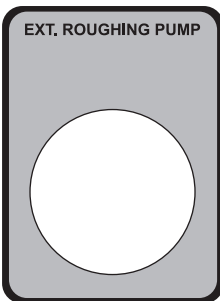
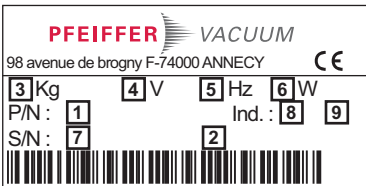
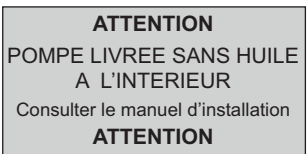
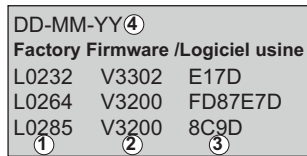
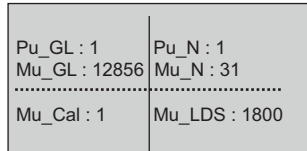
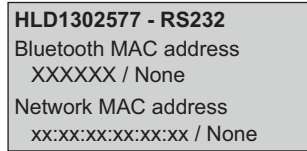

Quality: certifies that the product has been certified compliant with quality control upon leaving the factory.

Indicates whether the Bluetooth, Wi-Fi or Ethernet options have been installed on the products, and their MAC addresses.

For service centers use only.

Indicates the firmware versions installed on the product.

- 1) Firmware name
- 2) Firmware version
- 3) Firmware checksum
- 4) Publication date

Wet model only: indicates that the primary pump has been drained of oil upon leaving the factory: oil must be added before the first detector switch on (see 5.4).

Product subject to the treatment of waste electronic and electrical equipment in accordance with directive 2002/95/EC.

Product identification label (see 4.1).

Integrable model only: indicate the connection inlet port of the primary external pump on the rear.



2 Safety

2.1 Safety precautions



Obligation to inform

Any person responsible for installing, using or maintaining the product must first read the security instructions in this operating manual and comply with them.

→ It is the operating customer's responsibility to protect all operators against the dangers associated with the product, with the media pumped and with the entire installation.



Installation and use of the accessories

The products can be fitted with special accessories. The installation, use and refurbishment of the connected accessories are described in detail in the respective manuals.

→ Only use original accessories.

→ Accessory part numbers: see **Accessories**.



WARNING

Hazard associated with non-compliant electrical installation

Safe operation after installation is the operator's responsibility.

→ Connect the product to an installation that is compliant with local safety standards.

→ Do not carry out any alterations or modifications to the product on your own initiative.

→ For specific questions, contact your service center.



WARNING

Electric shock hazard in case of contact

When the product's circuit breaker is set at **O**, some internal components still have an electrical charge.

→ Make sure that the mains connection is always visible and accessible so that it can be unplugged at any time.

→ Disconnect the power cable from all power sources before starting any work on the product.



WARNING

Other localized hazardous energies

Electrical circuit and other pressurized circuits as nitrogen are potential hazards:

→ Always lock out these energy sources before working on the product.



WARNING

Risk associated with process gases

A leak detection operation must be carried out under environmental conditions that do not present any risks to the operator and the equipment. The user and/or integrator of the product are fully responsible for the operational safety conditions of the equipment. Therefore the user of the detector must:

→ not test parts or equipment with traces of harsh, chemical, corrosive, inflammable, reactive, toxic, or explosive substances, nor condensable vapours even in small amounts. Do not use the nitrogen purge system to dilute these hazardous products: that is not what it is intended for!

→ apply specific safety instructions in accordance with local regulations. For more information, contact your service center.





NOTICE

Filling with oil
 → Oil must be added to the primary pump before the detector is switched on.

The potential hazards for a leak detector involve electricity, the tracer gas, the pressurised nitrogen supply and the lubricant (for the Wet models).

- Only qualified personnel trained in safety rules (EMC, electrical safety, chemical pollution) may carry out the installation and maintenance described in this manual. Our service centers can provide the necessary training.
- Do not remove the blanked-off flange from the inlet port while the product is not in use.
- Do not expose any part of the human body to the vacuum.
- Comply with all safety and risk prevention instructions in accordance with local safety standards.
- Regularly check compliance with all precautionary measures.
- Do not turn on the product if the covers are not in place.

2.2 Protective equipment

In some situations, personal protective equipment must be worn when handling the detector and its components. Customers must provide operators with the necessary equipment. This equipment must be checked regularly and used in accordance with the supplier's recommendations.



DANGER

Health hazard in case of contact with the operating fluid
 Contact with or inhaling products such as oil from the pump can cause irritation.
 → Wear appropriate protective equipment when carrying out maintenance or adding/draining oil.



WARNING

Risk of injury due to falling objects
 When transporting parts/components and during maintenance there is a danger of loads slipping and falling down.
 → Carry small and medium-size parts/components with both hands.
 → Carry parts/components > 20 kg with a suitable lifting device.
 → Wear safety shoes with a steel toe in accordance with directive EN 347.



WARNING

Risk of injury through hot surfaces
 The products are designed so as not to present a thermal risk for the operator's safety. However, specific operating conditions may exist that require extra caution from users due to the high temperatures (surfaces > 70 °C for parts inside the covers).
 → Leave the part to cool before working on the product.
 → If necessary wear protective gloves according to directive EN 420.



CAUTION

Risk of pinching
 When handling the storage tank cover, there is a risk of fingers becoming pinched.



2.3 Proper use



NOTICE

EC conformity

The manufacturer's declaration of conformity becomes invalid if the operator modifies the original product or installs additional components.

→ Following installation into a plant and before commissioning, the operator must check the entire system for compliance with the valid EU directives and reassess it accordingly.

- The leak detector is designed to detect and/or quantify a possible installation or component leak by searching for the presence of a tracer gas in the pumped gases.
- Only the tracer gases identified in this manual may be used.
- The parts to be tested must be clean and dry.
- The product may be used in an industrial environment.

2.4 Improper use

Improper use will cause all claims for liability and warranties to be forfeited. Improper use is defined as usage for purposes deviating from those mentioned above, especially:

- pumping harsh, chemical, corrosive, inflammable, reactive, toxic or explosive fluids
- pumping of liquids
- pumping of condensing vapors
- pumping dust or solids particules,
- operation in potentially explosive areas
- analysis of gas with a hydrogen concentration higher than 5 %
- testing parts that are soiled or that have traces of water, vapours, paint, adhesive, detergent or rinsing products
- use of accessories or spare parts, which are not named in this manual

The product is not designed to carry people or loads and is not for use as a seat, step-ladder or any other similar purpose.

3 Transport and storage

Upon delivery, check that the product has not been damaged during transport. If the product is damaged, take the necessary measures with the carrier and notify the manufacturer. In all situations we recommend:

- Keeping the product in its original packaging so it stays as clean as it was when dispatched by us. Only unpack the product once it has arrived at the location where it will be used.
- Keeping the packaging (recyclable materials) in case the product needs to be transported or stored.
- Keeping the blanked-off plate on the inlet port when the product is not in use.
- Keep the blank-off flange on the pipe connection of the primary external pump (Integrable model only) when the product is not in use.

3.1 Transport



WARNING
<p>Risk of injury associated with heavy loads</p> <p>Given the weight of the product, it should be removed from its packaging only by personnel qualified and trained in handling heavy materials.</p> <ul style="list-style-type: none"> → Use the yellow lifting handles installed on the product (re-install if they have been removed). → The manufacturer cannot be held liable for the consequences of using lifting devices other than those provided.



WARNING
<p>Risk of tilting</p> <p>Even though compliance with EEC safety rules is guaranteed (normal tilting $\pm 10^\circ$), all necessary precautions should be taken when moving, installing and operating the product.</p> <p>When the detector is used on the trolley (accessory):</p> <ul style="list-style-type: none"> → Attach the detector to the trolley. → Do not place the product on an inclined plane: its weight could cause the operator to be dragged. → Place it on a flat, hard floor. → Do not push the product sideways. → Only use the trolley to move it short distances.



NOTICE
<p>Work/Handling the detector</p> <p>The operator must not work on the product to move it or carry out maintenance until it has come to a complete shutdown! When the circuit breaker is set at O, you must:</p> <ul style="list-style-type: none"> → Unplug the power cable. → Wait for the control panel screen to turn off completely before working on the product and/or removing the covers.



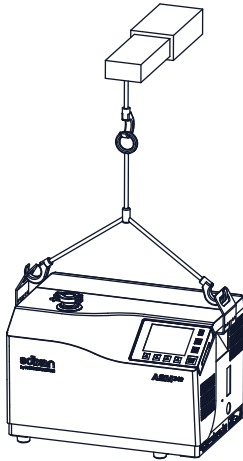

Before moving a detector, make sure that the covers are properly attached:

- The front cover cancels 3 fixing screws for the rear cover (out of the 5 screws in total): make sure that these 3 screws are in place and properly tightened.
- Make sure that all the fixing screws for the covers on the detector frame (5 screws for the rear cover and 4 for the front cover) are in place and properly tightened.

To lift the product:

- Use a lifting device appropriate for the product's weight.
- Use a 3-section strap with the following characteristics:
 - length of each section > **500 mm**
 - load per section > **100 kg**

3.2 Storage



Storing a new product

NOTICE
<p>Obligation to inform</p> <p>We took care to provide you with a clean product. So that it stays clean, we recommend storing it in its original packaging.</p>



If a new detector must be stored for more than three months:

- leave it in its packaging,
- leave the blanked-off flange in place on each port,
- store it in a clean, dry environment for a maximum of 3 months, in accordance with the temperature conditions specified in the **Technical Characteristics** (see 11.2).

Beyond 3 months, factors such as temperature, humidity, salt in the air, etc., could damage some components (elastomers, lubricants, etc.). If this happens, contact your service centre.

Extended storage

Recommended shutdown procedure before extended storage:

- Place the blanked-off flange on the inlet port.
- In the menu **[Test]**, check:
 - that the 'hard vacuum' test method is selected,
 - that the air inlet valve is set to 'Operator'
- Start a test by pressing : wait until the detector reaches the most sensitive test mode.
- Make sure that the inlet vent is inactive.
- Stop the test by pressing .
- Shut down the detector: circuit breaker **MS** to **O**.
- Wait for the control panel turn off.
- Unplug the power cable.

In this way, the detector is under a vacuum, reducing the degassing time spent when it is switched on again.



4 Product description

4.1 Product identification

To correctly identify the product when communicating with Pfeiffer Vacuum, always have the information from the rating plate available.

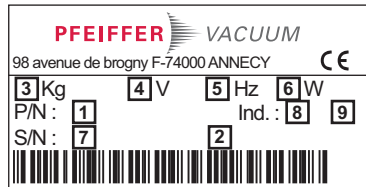

Fig. 1: Nameplate example

1	Part number
2	Description
3	Weight
4	Operating voltage
5	Operating frequency
6	Maximum power consumption
7	Serial number
8	Index
9	Date of manufacture

4.1.1 Scope of delivery

- 1 leak detector
- 1 documentation set (CD-ROM, operating instruction, plastic coated memos for the detector and the RS-232)
- 1 power cable for Europe (France/Germany) and/or 1 power cable for US
- 2 lifting handles installed on the product
- 1 calibration certificate for the internal calibrated leak
- 1 funnel (Wet model only)
- 1 oil can (Wet model only)
- 1 draining connector (Wet model only)
- 1 maintenance kit
- 1 plastic DN 25 ISO-KF blank-off flange (Integrable model only)
- 1 protective cover

4.1.2 Variants

The ASM 340 leak detectors are particularly suitable in Industry for vacuum and sniffing leak detection, in various applications from maintenance to small production applications. Easy operation, robustness, ultra fast response time, are among the outstanding features of these compact multipurpose units.

ASM 340, conventional pumping

Using a 15 m³/h rotary vane pump, this unit delivers unmatched performance in a compact design. It will be named Wet Model in this manual.

ASM 340, dry pumping

Available with diaphragm pump, it is the perfect unit for clean applications where no pollution can be tolerated.

It will be named Dry Model in this manual.

ASM 340, without primary pumping

For greater versatility, this can be used to adjust the proportions of the main pump to suit roughing needs.

It will be named Integrable Model in this manual.



4.2 Interface connection

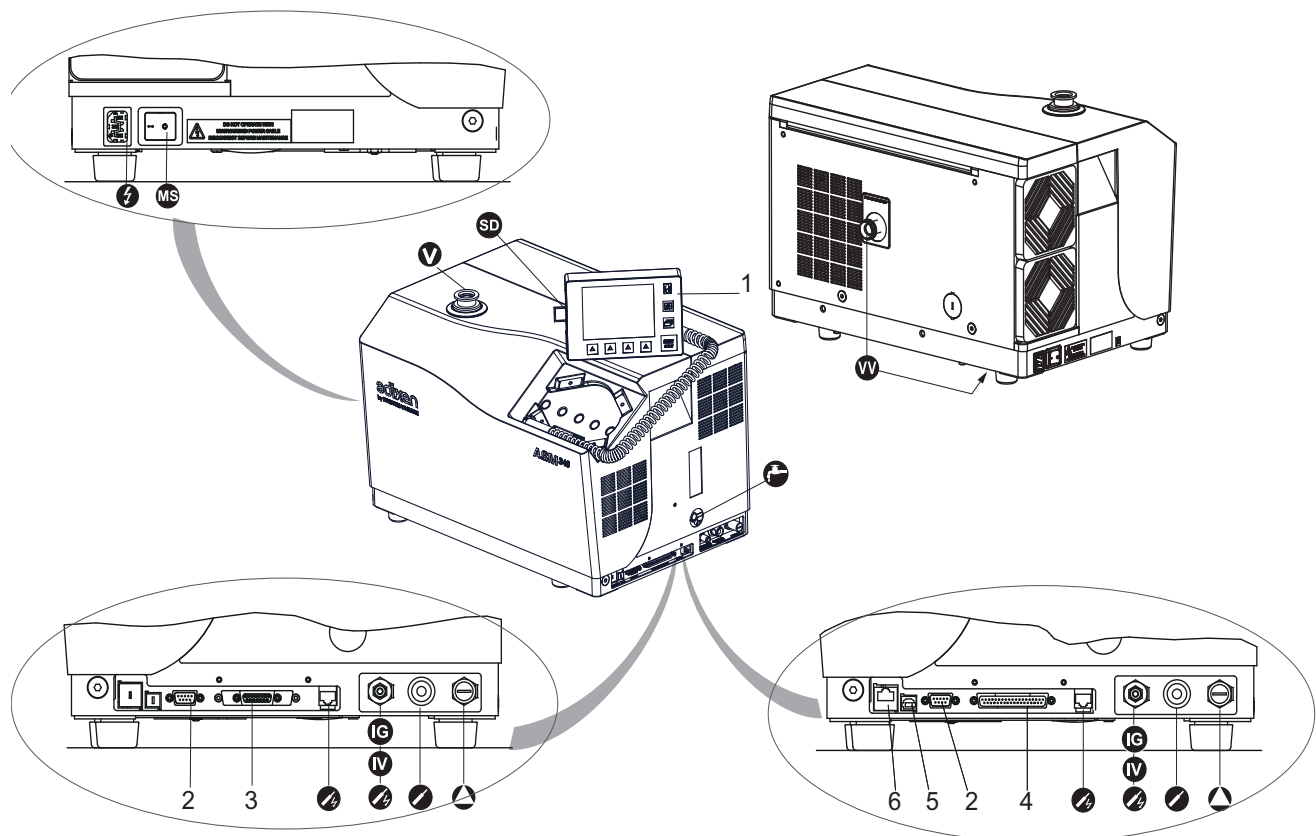

Fig. 2: Human-machine interface

⚡	Mains power supply	SD	SD card
V	Detector inlet (Inlet port)	⚡	Standard sniffer probe connection ⁽²⁾ (STANDARD SNIFFER)
⚡	Primary pump Exhaust (EXHAUST) (Wet & Dry Models)	⚡	Smart sniffer probe connection ⁽²⁾ (SMART SNIFFER)
MS	Switch/Circuit breaker	⊖	Oil draining (Wet Model)
IG	Neutral gas inlet (purge) (SMART SNIFFER/VENT/PURGE)	⊖	Filling with oil (Wet Model)
IV	Air inlet	VV	Primary pumping connection (Integrable Model)
1	Standard remote control connector ⁽²⁾	4	Interface Connector- I/O D-Sub 37 pins (INPUTS/OUTPUTS) ⁽¹⁾
2	RS-232 connector D-Sub 9 pins (SERIAL)	5	USB plug (USB)
3	Interface Connector- I/O D-Sub 15 pins (INPUTS/OUTPUTS) ⁽¹⁾	6	Ethernet plug ⁽¹⁾ or Wi-Fi Antenna ⁽¹⁾ (NETWORK)

(1) Accessory or option (at the customer's expense)

(2) Accessory (at the customer's expense)

4.3 Test methods

The test method is chosen depending on the part to be tested. For more information about leak detection test methods, see **Leak detector compendium** on the website www.pfeiffer-vacuum.com.

4.3.1 Hard vacuum test

- Part that can be connected to pipe and placed under a vacuum.
- Part that can be placed in a vacuum chamber.

Spray method This method involves removing the air from the part to be tested, connecting it to the detector's analyzer cell, then spraying tracer gas on the points of the part that are likely to leak.

The detector measures the flow of tracer gas that penetrates due to part leakage.

When spraying starts, the leak rate is not displayed instantaneously: there is a response time which depends on the volume V being tested and the tracer gas pumping speed S of the system at the opening of the part, according to the following relation:

$T = V/S$ (where T = seconds, V = litres, S = l/s).

T is the time required for the leak rate to reach 63 % of the final value.

Bombing method The part is placed ahead of time in a pressurised gas tracer chamber. The tracer gas penetrates the part through the potential leaks. Then the part is removed from the chamber and placed in another vacuum chamber and connected to the detector.

The detector measures the flow of tracer gas that leaks out of the part.

4.3.2 Sniffing test mode

- Part that can be connected to pipe and cannot be placed under a vacuum.

The part to be tested is pressurised with tracer gas.

The detector measures the flow of tracer gas that leaks out of the part through a sniffer probe that moves across all the points prone to leaking.

The detector measures the flow of tracer gas that leaks out of the part.

The measured leak rate is not an exact measurement of the leak. The sniffer probe only detects part of the tracer gas escaping from the part, depending on the distance separating the crack from the tip of the probe, and the direction of the leak in relation to the probe.



5 Installation

5.1 Prerequisites for optimising measurement

To optimise pumping and measurement speed:

- Use pipe with a diameter equal to the diameter of the detector's inlet. The pipes should be as short as possible and completely sealed.
- Do not use plastic hoses such as compressed air pipes.
- Check that the connected part/installation is impermeable to tracer gas.
- Test only clean, dry parts/installations with no trace of water, vapour, paint, detergent or rinsing products.
- Test that the entire line is completely sealed when the detector is attached to the pumping circuit, to ensure that the connections are correct (pump, pipe, valves, etc.).

5.2 Operating conditions



DANGER

Explosion hazard.

For detecting leaks with 'hydrogen' tracer gas, the operator must use hydrogenated nitrogen (mix of 95 % N₂ and 5 % H₂).



NOTICE

Risk of pollution from solid substances

When applications generate particles, we recommend protecting the detector's inlet.

→ Install an inlet filter and possibly a Bypass (see 10).



NOTICE

Detector ventilation

If there is insufficient ventilation, overheating could cause damage to the components:

→ Comply with the ambient operating temperature.

→ Do not obstruct the air vents.

→ Leave a gap of 70 mm around the air vents.

Environmental conditions (see 11.2).

5.3 Set-up

The leak detector must be installed on a flat, horizontal surface, supported by its feet, with the detector's inlet port on the top.

→ Choose the location for set up according to the dimensions of the detector: chapter **Technical Characteristics** (see 11.2).

→ Move the detector with a hoist, using the handling devices (see 3.1).

5.3.1 Storing the lifting handles

Once the detector has been installed, the handles can be removed and stored in the back of the detector or used to place the control panel on a work surface.

Tools required

- 5-mm Allen key.

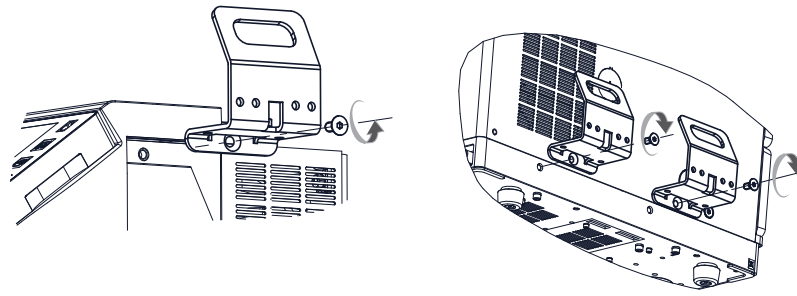

Fig. 3: Storing the lifting handles

5.3.2 Control panel equipment

The control panel can be placed on a work surface using the lifting handles for support.

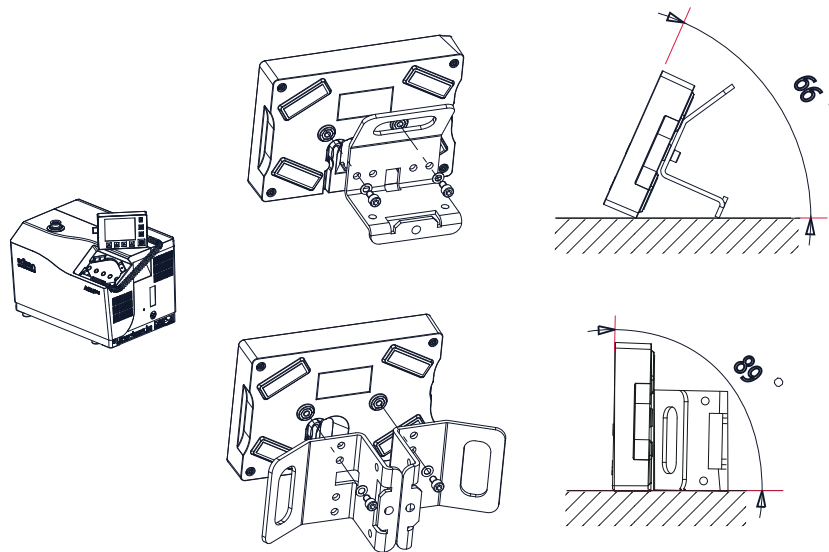

Fig. 4: Control panel on work surface

→ Attach the handles with 2 CHc M6 x 10 screws and 2 \varnothing 6 mm bolts (at customer's expense).

5.4 Filling with oil (Wet model only)



DANGER
<p>Health risk in case of oil contact</p> <p>The pumps are delivered empty of oil: the oil is delivered in separate containers.</p> <p>→ Wear mask, gloves, protective glasses to fill the pumps with oil.</p>

NOTICE
<p>Only use approved operating fluids</p> <p>The pumps are factory tested using Pfeiffer Vacuum oil.</p> <p>→ The same oil must be used during operation. The oil safety data sheet is available on the website.</p>

- Make sure that the detector is off (circuit breaker MS at O , the control panel screen is off) and in a horizontal position.
- Open the cover.
- Remove the oil fill cap (1) from the rotary vane pump (2).



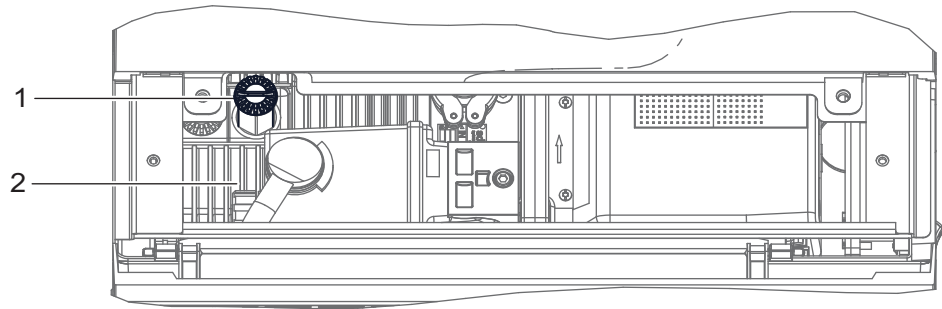

- Put the funnel (included with the detector) in the oil fill opening (3).
- Fill with oil to the highest level.

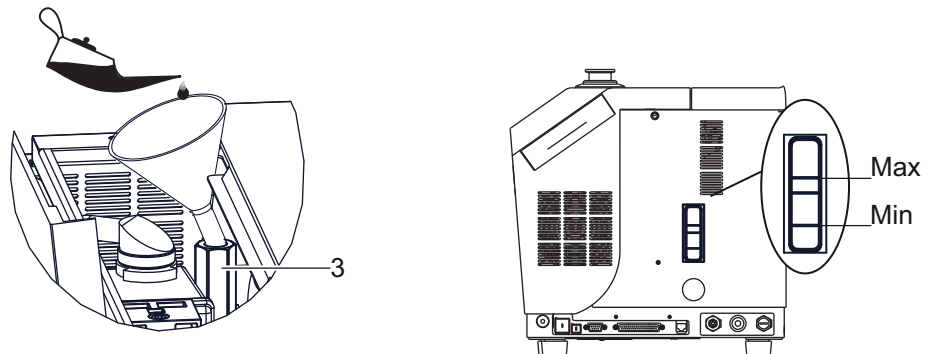

- Replace the oil fill cap tightly (1).

5.5 Connecting the purge circuit

The Dry and integrable Model's purge system can be connected to a purge circuit and can be open/closed depending on the settings.

The Wet Model's purge system is always closed and cannot be set by the operator.



NOTICE

Tracer gas concentration

When the air purge is used, we recommend performing the leak detection in a ventilated room.



WARNING

Pressurised circuit

To work safely on the product, the operator must:

- Install a manual valve on the nitrogen circuit at a distance of 3 m from the product, so that the nitrogen supply can be locked.

To guarantee best performance, the nitrogen supply must be clean and filtered, with the following characteristics:

- relative excess pressure: 200 hPa
- flow rate: 50 sccm

- Attach the nitrogen pipe to the connector  (see 4.2).



5.6 Connection to the mains power supply



WARNING

Risk of electromagnetic disturbance

The product's EMC behavior is guaranteed only if the relevant EMC standards are followed during installation.

→ Use shielded cables and connections for the interfaces in interference-prone environments.



WARNING

Hazard associated with non-compliant electrical installation

Safe operation after installation is the operator's responsibility.

→ Connect the product to an installation that is compliant with local safety standards.

→ Do not carry out any alterations or modifications to the product on your own initiative.

→ For specific questions, contact your service center.



The leak detector is Class 1 equipment and therefore must be earthed.

5.7 Operating for the first time

Wet Model → Check that the oil level of the primary pump is between the maximum and minimum levels (see 5.4).



Integrable Model → Make sure that the client's primary pump is connected to the detector (see *chapter on Connection of the primary pump in the Maintenance Manual*) and is switched on.

All Models

- Attach the electrical network to the connector  using the power cable.
- Set the circuit breaker  to I.
- Set the language, unit, time and date (the operator can modify this at a later time (see 7.7.1)).
- Wait for the detector to enter Stand-by mode.



5.7.1 Familiarise yourself with the control panel

Control panel description (see 6.1.2).

- Press  several times to familiarise yourself with the application screens.
- Press  several times to see the 2 levels of function keys available.
- For each level, press  or the control panel function key to access the function.

5.7.2 Become familiar with the detector

You can carry out a hard vacuum test and learn about your detector simply by performing a test on the equipment itself.

- Leave the blanked-off flange included with the product in place on the detector's inlet.
- Start a test by pressing . The measured leak rate is displayed: this is the detector's background.
- Stop the test by pressing .
- To remove the blanked-off flange from the detector's inlet, press **[Inlet vent]**.



5.8 Connecting the part/installation to be tested



NOTICE

Limit of operation

→ Make sure that the parts or chambers connected to the inlet of our products withstand a negative pressure of $1 \cdot 10^3$ hPa in relation to atmospheric pressure.

- The inlet pressure must be no higher than atmospheric pressure. Pressure that is too high can damage the product.
 - The detector's performance depends on the type of accessories used and on the quality of the mechanical connections.
 - When assembling the vacuum circuit, use accessories to shut off the product and make maintenance easier (inlet shut off valves, purge systems, etc.).
 - Comply with these recommendations (see 5.1) to optimise measurement.
 - The maximum permitted weight at the detector's inlet must be no more than 15 kg and the maximum torque must be 10 N·m.
- Remove the blanked-off flange that covers the detector's inlet and save it for reuse during storage or transport.
- Connect the part or the equipment using the connection accessories available in the product catalogue.
- Test that the entire line is completely sealed when the detector is attached to the pumping circuit, to ensure that the connections are correct (pump, pipe, valves, etc.).

5.9 Connecting the exhaust



NOTICE

Limit of operation

→ Make sure the exhaust pressure does not exceed 200 hPa (relative). Pressure that is too high can damage the product.

Dry Model The detector's exhaust is equipped with an external filter. Make sure that it is never obstructed: clean it regularly.

Wet Model



NOTICE

Wet Model - Pumping at high pressure

→ Connect the exhaust to an exhaust duct. 1/8 Gas connection.

The detector's primary pump is equipped with an internal oil mist eliminator. The operator can connect an external eliminator instead of this internal eliminator. Install a pipe connection designed for this purpose, available as an accessory (see *chapter Replacement of the internal oil mist eliminator with an external oil mist eliminator in the Maintenance Instructions*).

5.10 Connection the primary pump (Integrable Model)

The leak detector must be connected to a primary pump before startup (see *chapter Connection the primary pump in the Maintenance Instructions*).

5.10.1 Characteristics of the primary pump

- Wet or Dry pump in DN 25 ISO-KF
- Empty limit < 1 mbar ($5 \cdot 10^{-2}$ mbar recommended)



- Minimum throughput = 1 m³/h
If used as a sniffer with a Smart probe, minimum throughput = 3 m³/h
- Maximum throughput = 100 m³/h
A greater throughput does not improve the performance of the leak detector/primary pump combination.
- Maximum 2 m-long flexible tube between the detector and primary pump

5.10.2 Connection of the primary pump

Two possible DN 25 ISO-KF connections: on the rear or under the detector frame.
The leak detector is delivered with the connection at the rear.

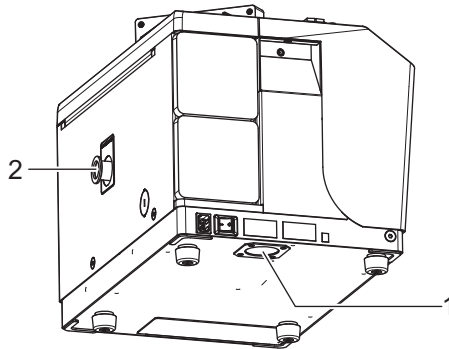

Fig. 5: Rear connection

1	Stopgap plug
2	DN 25 ISO-KF pipe connection

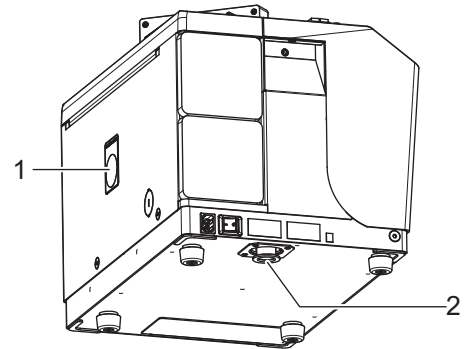

Fig. 6: Connection under the detector frame



6 Operation

6.1 Control panel

It is interfaced with the detector and is used to:

- display information about the test
- access the available functions
- setting of the detector's parameters.



For a screenshot, set a function key to [Screen Copy] (see 7.7.2).

6.1.1 Description

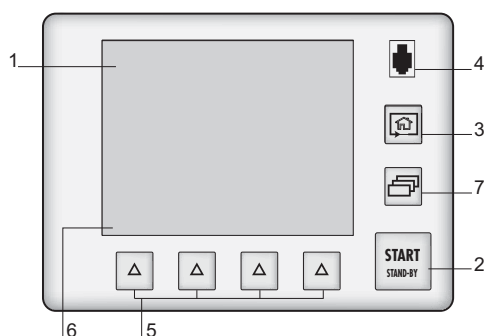









Fig. 7: Control panel

1	Application screens (touch screen): these are accessible or hidden (see 7.7.3).
2	Test Start/Stop.
3	Changing the application screens: return to the home page (standard screen) from any menu.
4	Standard remote control connection (accessory).
5	Accessing the functions for daily use. Functions assigned to a key by the operator (provides access to the functions if there is a problem with the touch screen).
6	Displaying a function key level: starting the function or displaying a sub-menu by touching the screen.
7	Changing the level of function keys.

➔ Remove the film that protects the screen upon delivery.



➔ Use the touch screen manually without using hard objects such as pens, screwdrivers, etc.

	Function deactivated (OFF)
	Function activated (ON)
	Authorized access without password
	Access locked: access with password
	"Grey" key: access settings or function
	"White" key: key not customisable, for information
	"Measurement information" key: to display the measured leak rate
	Arrows for navigating within the menus
	Access to the error/warning window

	Value selected is customisable
	Keys for setting the values
	Moving to the next function/screen/parameter
	Return to the previous display
	Return to the previous display and confirm the changes made
	Return to the previous display without confirming the changes made
	Deleting the selected file

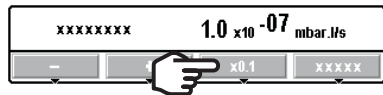
Set point setting



- 1  → 1.0 x10⁻⁰⁷
- 2  → 1.0 x10⁻⁰⁷
- 3  → 1.0 x10⁻⁰⁷

1	Exponent setting
2	Mantissa unit setting
3	Mantissa tenth setting

6.1.2 Contrast - Brightness - Screen Saver

(see 7.7.4)



6.1.3 Application screens

The content of the screens is given as an example. Depending on the leak detector and parameters, the display may be different.

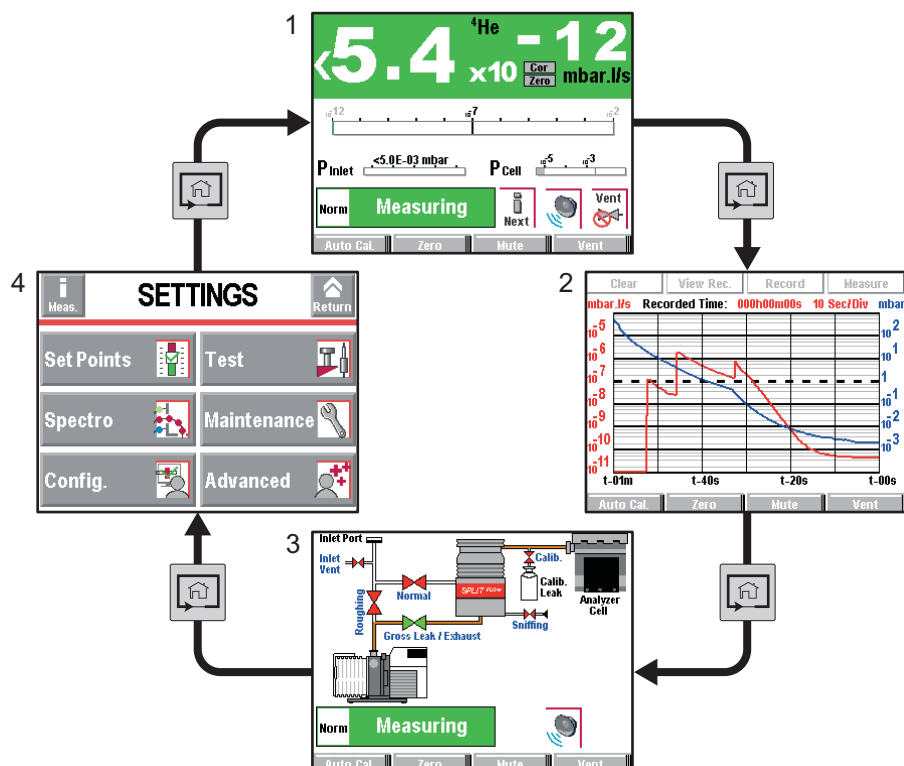

Fig. 8: Example of each screen

1	"Standard" screen (home)
	Information about the current test
2	"Graph" screen
	Monitoring and recording the leak rate and/or the inlet pressure
3	"Vacuum circuit" screen
	Vacuum circuit of the detector and the status of the valves
4	"Settings" screen
	Detector parameters



The operator can hide and/or switch certain screens in the loop (see 7.7.3).
 For daily use, after the detector's parameters have been set consult primarily the "Standard" screen.

6.1.4 "Standard" screen

Information about the test: display most often shown during a test.

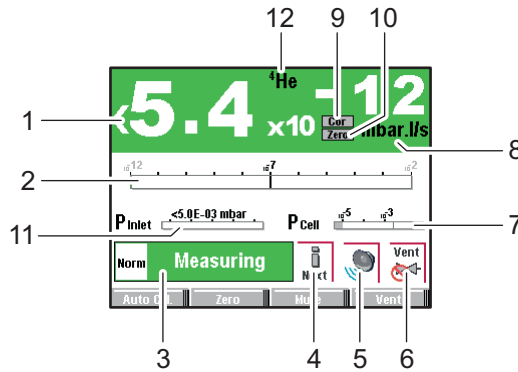

1	Digital display of the leak rate (green \leq reject set point < red)
2	Bargraph display of the leak rate (adjustable scale)
3	Detector status and Detection mode
4	Access error information
5	Mute function indicator
6	Air inlet function indicator (except ASI 30/35)
7	Cell pressure bargraph display
8	Leak detector unit
9	Leak rate correction function indicator
10	Zero function indicator
11	Detector inlet pressure display (unit consistent with the leak rate unit)
12	Tracer gas (^3He , ^4He or H_2)



A password can be used to lock access to the "Settings" menus while leaving certain functions accessible using the function keys (see 7.7.2).

Integrable Model : Digital display of the leak rate in gross leak mode (see 7.4.3).

6.1.5 "Settings" screen

Setting the detector's parameters.

The "Settings" screen is accessible from any window, by pressing the following two keys at the same time + .

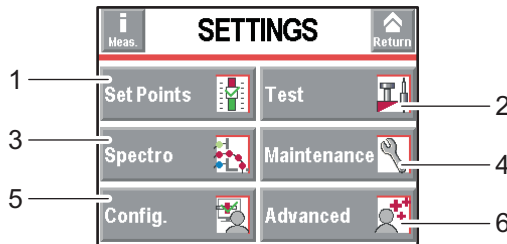

1	Set points setting: reject set point, audio level, digital voice, pollution.
2	Method and test mode selection. Inlet vent management. Correction value. Cycle end.
3	Tracer gas selection. Setting the calibrated leak.
4	Scheduling maintenance
5	Detector setting for the operator: language, unit, password, function keys, application screens.
6	Advanced functions reserved for specific detector uses.



6.1.6 "Graph" screen

Monitoring and recording the leak rate and/or the inlet pressure.

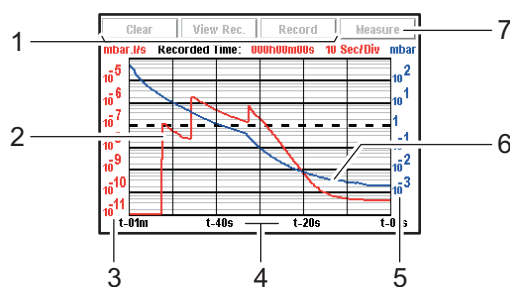

1	Deleting/Viewing/Recording a plot
2	Plot of the tracer gas leak rate (in red)
3	Scale of the tracer gas leak rate (in red)
4	Time scale
5	Inlet pressure scale (in blue)
6	Inlet pressure plot (in blue)
7	Displaying/Hiding the Measurement window (see 6.1.8)

6.1.7 "Vacuum circuit" screen

Vacuum circuit of the detector and the status of the valves.

The vacuum circuit varies depending on the status of the valves, but does not make it possible to manage the valves.

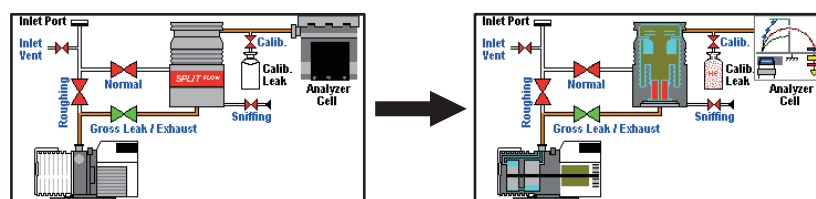

Fig. 9: Example of a vacuum circuit (ASM 340)

Red valve	Valve closed
Green valve	Valve open
Pumps, Analyzer cell	⇒ Press the component to display the operating principle.

6.1.8 "Measurement" window

→ Press the **[Measure]** key to display the window.

→ Press and drag the window to move it on the screen.

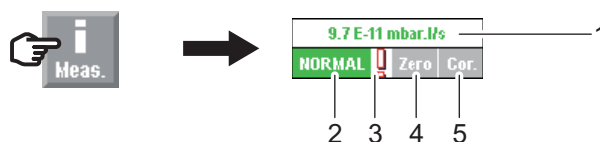

Fig. 10: **[Measure]** key and corresponding window

1	Digital display of the leak rate (green \leq reject set point < red)
2	Detector test mode
3	Error information indicator
4	Zero function indicator
5	Leak rate correction function indicator

Integrable Model : the digital display of the leak rate in gross leak mode is specific (see 7.4.3).

6.1.9 Function keys

The function keys are used to activate/stop a function or to set set points (see 7.7.2).



Thanks to the function keys, it is possible to give the operator access to a limited number of functions and to use a password to lock unauthorised functions on the "Settings" menu. they are sufficient to manage the detector.

- To allow the operator to use only the [Start/Stand-By] key, do not allocate a function to the function keys and lock the "Settings" menu.
- Up to 4 additional function keys can be added, for a maximum of 12. In this case, a 3rd level is made available to the operator.

6.2 Prerequisites to use

The leak detector is set to perform a hard vacuum test in the most sensitive test mode according to the initial settings (see 7.2.1).

For use with any other parameters or other functions, see **Chapter 7**.

All models



NOTICE

Risk of seizing

- Never move the detector while it is in use, even if it is placed on a trolley.

Wet model



NOTICE

Filling with oil

- Oil must be added to the primary pump before the detector is switched on.

Integrable model



NOTICE

Connecting the primary pump

- The external primary pump must be connected and powered up before the detector is switched on.

Before each switching on:

All models

- Become familiar with the safety instructions (see 2).
- Remove the cover before using the product.
- Check that all the connections are correct (see 5).
- Before use, make sure that the leak detector is in an environment free of tracer gas.
- Check that the electrical network is properly attached to the connector ⚡ using the power cable.

Model Wet

- Check that the oil level of the primary pump is between the maximum and minimum levels (see 5.4).

6.3 Switching the detector on

6.3.1 Switch on

- Set the circuit breaker  to I (see 4.2).

The various stages for switching the detector on are displayed. The detector is ready for testing when the Stand-by screen appears.



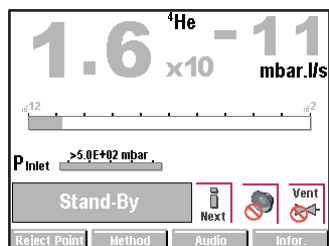

Fig. 11: Stand-by screen

Switching the detector on for the first time

(see 5.7)

Switching on after an extended shutdown

If the detector has been stored or has not been used, switching on time will be longer than if it is in regular use.

6.3.2 Starting a test

Hard vacuum test

There are 2 possible test methods: hard vacuum or sniffing(see 4.3).

- Select the 'hard vacuum' test method (see 7.4.1).
- Set the detector to Stand-by mode.

In Stand-by mode, the leak rate displayed corresponds to the detector's background.





- Connect the part to be tested to the leak detector inlet port or put the part in the test chamber connected to the leak detector.
- Set the reject set point if necessary(see 7.3.3).
- Start a test by pressing .

The various test stages are displayed.

- When the detector has reached the most sensitive test mode, wait for the measurement to stabilise: the measurement displayed corresponds to the measured leak rate.
- Stop the test by pressing .

The test can also be started using a remote control (accessory): see *Remote control Operating instructions*.

Sniffing test

- Select the 'sniffing' test method (see 7.4.1).
- With the leak detector in Stand-by mode, connect the sniffing probe (accessory) to the provided connector ( or ) and select Standard or Smart probe model (see 7.4.4).
- Set the reject set point if necessary (see 7.3.4).
- Start a test by pressing  : the leak rate is displayed.
- Stop the test 78 pressing .

6.4 Monitoring operation

When the detector is in use, the operator is alerted to incidents as follows:

- Pictogramme display indicating that the error message should be read.
- Error display on the screen.

Message list: see **List of warnings/faults** in *Maintenance instructions*.

6.5 Shutdown the detector

- Set the circuit breaker  to **O** (see 4.2).
- Wait for the control panel screen to turn off completely before working on the product and/or removing the covers.

Shutdown due to a mains power failure

When there is a mains power failure, the detector shuts down: it switches on again automatically when power is restored.

6.6 Saving and downloading the product's configuration

When a detector is installed or replaced, it is helpful to copy the configuration (all the parameters and operating set points programmed by the operator) of a detector that is the same model.

→ Do this while the detector is switched on and in Stand-by mode.

6.6.1 Saving the configuration

→ Follow the procedure for saving (see 7.8.14).

The detector's configuration will be saved on the SD card from control panel.

6.6.2 Downloading the configuration

→ Follow the procedure for downloading (see 7.8.14).

The previous configuration is automatically updated.

All the detector's parameters are downloaded except the following, which must be set by the operator:

- language
- serial link (except ASM 310)
- time and date
- temperature unit (except ASI 35)
- pressure unit.



7 Advanced settings

7.1 "Graph" screen

→ Access the "Graph" screen by pressing .

7.1.1 Description

Monitoring and recording the leak rate and/or the inlet pressure.

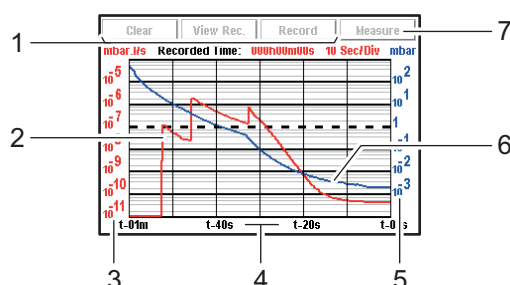

Fig. 12: "Graph" screen

1	Deleting/Viewing/Recording a plot
2	Plot of the tracer gas leak rate (in red)
3	Scale of the tracer gas leak rate (in red)
4	Time scale
5	Inlet pressure scale (in blue)
6	Inlet pressure plot (in blue)
7	Displaying/Hiding the measurement (see 6.1.8)

Scales (3), (4), (5) are adjustable by pressing the graph.

7.1.2 Settings

→ Access the graph settings menu by pressing the graph.

Display

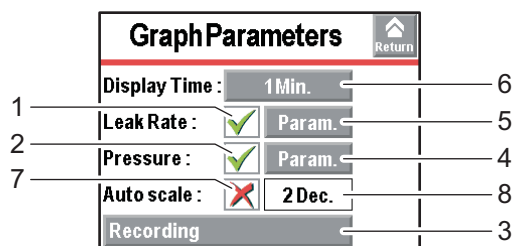

1	Displaying/Hiding the measured leak rate
2	Displaying/Hiding the inlet pressure
3	Setting the recording time
4	Setting the inlet pressure scale
5	Setting the leak rate scale (If 'automatic' scale is deactivated)
6	Screen scroll speed
7	Activating/Deactivating the automatic scale
8	Setting the automatic scale

Automatic scale

The automatic scale is used to display the measured leak rate centred on 2 or 4 decades. The scale varies according to the leak rate measured. When the automatic scale is activated, the scales set for the leak rate and pressure are no longer taken into account.

Example: leak rate = $5 \cdot 10^{-8}$ Pa·m³/s ($5 \cdot 10^{-7}$ mbar·l/s)

- automatic scale 2 decades: scale from $1 \cdot 10^{-7}$ to $1 \cdot 10^{-9}$ Pa·m³/s ($1 \cdot 10^{-6}$ to $1 \cdot 10^{-8}$ mbar·l/s)

- automatic scale 4 decades: scale from $1 \cdot 10^{-6}$ to $1 \cdot 10^{-10}$ Pa·m³/s ($1 \cdot 10^{-5}$ to $1 \cdot 10^{-9}$ mbar·l/s)

Recording → Press **[Recording]**.

Duration	Recording duration	
Capacity	Total recording time according to recording duration	
Duration	Maximum capacity	File size
0.2 s (min.)	6 hours 33 minutes	≈ 7 Mo
30 s (max.)	983 hours	

7.1.3 Recording

Recording makes it possible to store the measurements taken during the test in the control panel memory: **it will not save these measurements** (see 6.1.1).

During a recording, all the detector functions are available.

After the detector is switched off (cut off at the mains or by the operator), the recordings already made are stored in the memory. For the next recording, the operator will have to specify:

- if the new recording is to be added to the recordings in the memory **[OK]**
- if the new recording is to delete or replace the recordings in the memory **[Cancel]**.

- Change the recording parameters if necessary.
- Press **[Record]** (1) (see 6.1.1) to start recording

None of the measurements displayed on the plot before the recording starts will be recorded.

- Press **[Stop]** (1) to stop recording.
- Press **[View Rec.]** (1) to see the recording.

If the memory is not cleared between two recordings (**[Clear]** (1), all subsequent recordings will appear consecutively on the same memorised plot. A ▲ cursor indicates the end of each recording.

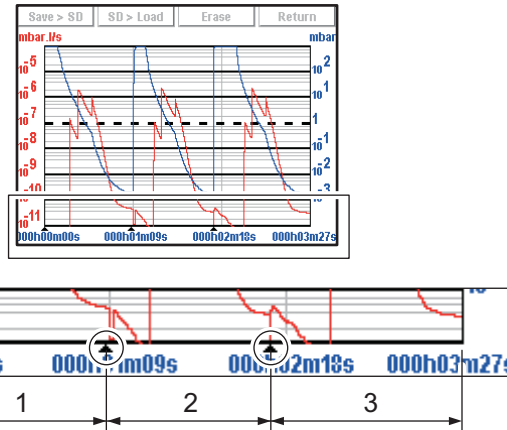

Fig. 13: Recording example

1	1 st recording
2	2 nd recording
3	3 rd recording

When the memory is full and if a recording is in progress, recording is automatically stopped.

The **[Record]** key is replaced by the **[Mem full]**.

7.1.4 Erasing

- Current window** → Display the "Graph" screen (see 6.1.1).
- Press **[Clear]** (1) and validate the message.



Clearing the current window does not delete the current recording or recordings already made.

- Recording**
- Display the "Graph" screen (see 6.1.1).
 - Press **[View Rec.]** (1).
 - Press **[Clear]** (1) and validate the message.

If the detector is carrying out a test while the previous recording is being deleted, the test is stopped.

7.1.5 Viewing a recording



At any time, the operator can view the recording already made or zoom in on a recording, without stopping the current recording.

- Press **[View Rec.]** to view the recording made since the last recording was deleted (1) (see 6.1.1).

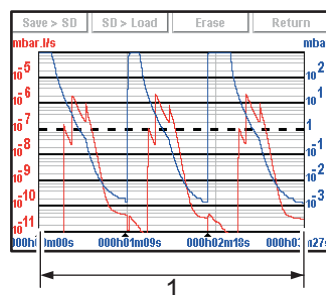

Fig. 14: Viewing a recording

1 | Total recording time

If no plots have been made, the message "Memory empty" is displayed.

- Zoom in**
- Zoom in available only for a recording.
- Press **[View Rec.]** (1) (see 6.1.1).
 - Set the area to be enlarged ((1) then (2)).

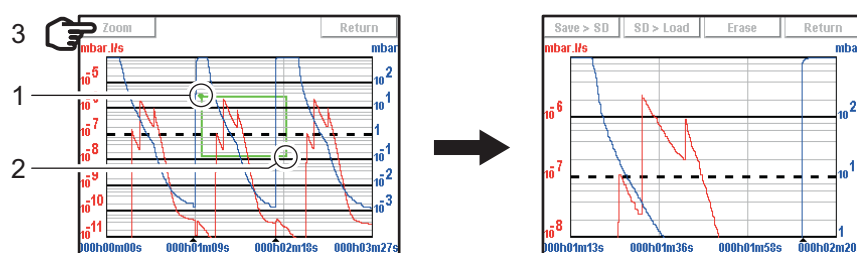

Fig. 15: Selection and viewing the area to be enlarged

- Press **[Zoom]** (3): the enlarged area is displayed.

Several successive zooms are possible (except in the same decade).



If necessary, adjust the area to be enlarged by dragging the corners or sides with your finger.

- Zoom out**
- Zoom out available only for a recording.
- Set the area to be reduced ((1) then (2)): return to the original graph.



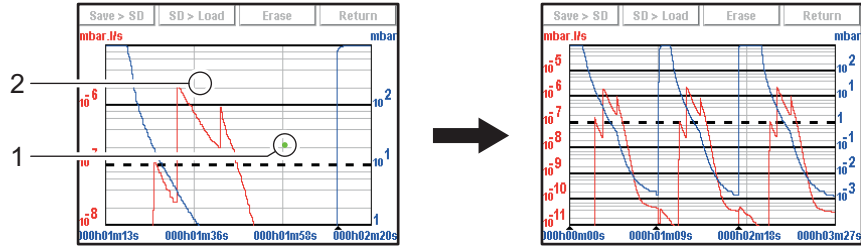

Fig. 16: Return to the original graph

Measurement

Exact measurement of a point only available on a recording.

➔ Select the point to measure (2).

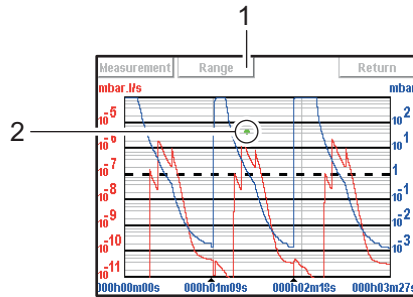

Fig. 17: Example of the recording of a point

- | | |
|---|---|
| 1 | Modifying the leak rate and inlet pressure scales |
| 2 | Point selected |

➔ Press [Measure]: the exact measurement of the selected point is displayed.

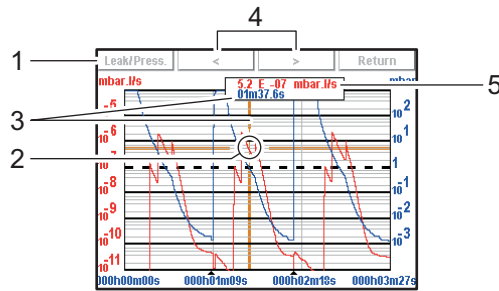

Fig. 18: Exact measurement of the selected point

- | | |
|---|--|
| 1 | Selecting the display of the leak rate or the inlet pressure |
| 2 | Marker indicating the selected point |
| 3 | Moment the measurement took place in relation to the start of the recording |
| 4 | Navigation between next/previous recorded points |
| 5 | Displaying the tracer gas leak rate (in red) or the inlet pressure (in blue) |



To make the exact values of all measurements available on any type of spreadsheet, save the recording to a .txt file.



7.1.6 Saving a recording

This function is used to save the most recent recording on a SD card to be played back/analysed later on a PC. Saving is not automatic.

It is possible to save a screenshot of the recording (.bmp) or to generate a file (.txt) with all the measurements taken. The .txt file can be used with any spreadsheet (e.g. Excel Microsoft® Office): the default separator is "tab".

→ Press **[Save > SD]** (see 6.1.1).

→ Name the file and save it

The saved .bmp and .txt files include only the measurement points displayed on the screen:

- to include all points, you must be positioned on the relevant plot (without zooming).
- if a zoom was carried out before saving, the zoom will apply only to the points of the selected zone.

If the saved recording is made up of several consecutive recordings:



- the ▲ cursor will indicate each new recording on the .bmp files.
- "B.P. # xx" will be noted at the end of the last line of each recording in the .txt files.

.bmp files can be displayed on the control panel screen.

.txt files can be opened only from a PC.

7.2 Settings

Screen for accessing the detector's settings menus to set the detector according the application. After this, for daily operation the functions keys will be used.

The "Settings" menu is accessible from any screen by pressing 2 keys  +  on the control panel simultaneously.

Access to the various menus can be locked (see 7.7.5).

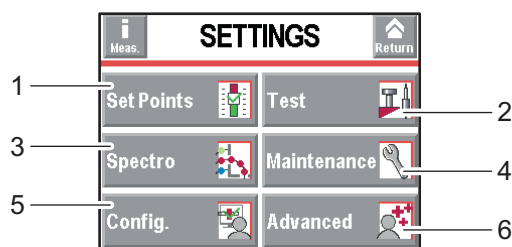

1	Setting the set points: reject set point, audio level, digital voice, pollution.
2	Method and test mode selection. Inlet vent management. Correction value. Cycle end.
3	Tracer gas selection. Setting the calibrated leak.
4	Scheduling maintenance. Detector information
5	Detector setting for the operator: language, unit, password, function keys, application screens.
6	Advanced functions* reserved for specific detector uses.

Table 1: * advanced settings requiring substantial knowledge about leak detection: pressure gauge, etc.

7.2.1 Tree diagram of the "Settings" menu

The following table shows the detector's initial settings. When the detector is off, all the memorised values and parameters are saved for the next use.

The operator can save and download different leak detector configurations (see 7.8.14).



The saved values are the values set at the time saving takes place.



SET POINTS			
Selection		Choice - Setting limit	Initial settings
Audio	Status	Invalid / Valid	Valid
	Setting (If valid)	1 - 9	3
Digital voice	Status	Invalid / Valid	Valid
	Setting (If valid)	1 - 9	4
Pollution	Status	Invalid / Valid	Invalid
	Setting (If valid)	$1 \cdot 10^{+19}$ - $1 \cdot 10^{-19}$	$1 \cdot 10^{-05}$
Hard Vacuum Set Points	Reject Point	$1 \cdot 10^{+06}$ - $1 \cdot 10^{-13}$	$1 \cdot 10^{-08}$
	Reject Point 2 (If I/O 37 pins)	$1 \cdot 10^{+19}$ - $1 \cdot 10^{-19}$	$1 \cdot 10^{-07}$
	Reject Point 3 (If I/O 37 pins)	$1 \cdot 10^{+19}$ - $1 \cdot 10^{-19}$	$1 \cdot 10^{-07}$
	Reject Point 4 (If I/O 37 pins)	$1 \cdot 10^{+19}$ - $1 \cdot 10^{-19}$	$1 \cdot 10^{-07}$
	Reject Point 5 (If I/O 37 pins)	$1 \cdot 10^{+19}$ - $1 \cdot 10^{-19}$	$1 \cdot 10^{-07}$
Sniffer set Points	Reject Point	$1 \cdot 10^{+06}$ - $1 \cdot 10^{-12}$	$1 \cdot 10^{-04}$
	Probe Clogged	With Standard probe	$1 \cdot 10^{+19}$ - $1 \cdot 10^{-19}$
		With Smart probe	0 - 9999

TEST					
Selection		Choice - Setting limit	Initial settings		
Method		Hard Vacuum / Sniffer	Hard Vacuum		
HV Correction	Status	Invalid / Valid	Invalid		
	Setting (If valid)	$1 \cdot 10^{+20}$ - $1 \cdot 10^{-20}$	$1 \cdot 10^{+0}$		
Mode	(If hard vacuum test method)	Gross leak / Normal	Normal		
ProbeType	(If sniffer test method)	Standard / Smart	Standard		
Cycle End	Automatic cycle end		Operator / Automatic		
	Setting (If automatic)	Roughing Timer	Status	Invalid / Valid	Valid
		Setting	0 - 1 h	10 s	
Test Timer	0 - 1 h	10 s			
Inlet Vent	Inlet Vent		Operator / Automatic		
	Delay		0 - 2 s	0 s	
	Vent Timer	Status	Invalid / Valid	Invalid	
Setting (If automatic)		0 - 1 h	9 s		
Memo Function	Active		Non / Oui	Non	
	Display Time	Status	Invalid / Valid	Invalid	
Setting (If automatic)		0 - 1 h	10 s		
Zero activation	Activation		None / Operator / Automatic		
	Zero Exit (if operator)		Press once / Press > 3 s	Press once	
	Value (If automatic)	Trigger	Timer / Set point	Timer	
Setting		If Timer	0 - 1 h	10 s	
		If Set Point	$1 \cdot 10^{+19}$ - $1 \cdot 10^{-19}$	$5 \cdot 10^{-7}$	
Bypass Option	Mode		None / Quick Pump. / Partial Flow		
	Evacuation delay		Off / On	Off	
Regeneration	Function launching		-		
Massive Mode	Active	Wet / Dry Model	No / Yes	Yes	
		Integrable Model	No / Yes	No	
	Sensitivity		High / Low	High	



SPECTRO				
Selection		Choice - setting limit	Initial settings	
Tracer Gas		Helium 4 / Helium 3 / Hydrogen	Helium 4	
Filament selected		1 / 2	1	
Filament		Off / On	On	
Filament Status		0 - 100 %	100 %	
Calibrated Leak	Tracer Gas		Helium 4 / Helium 3 / Hydrogen	
	Type		Internal / External	
	Unit		mbar·l/s / Pa·m ³ /s / Torr·l/s / atm.cc/s / ppm	
	Leak Value		-	Refer to certificate delivered with the detector
	Calibration valve		Closed / open	Closed
	Loss Per Year (%)		0 - 99	6
	Reference Temperature (°C)		0 - 99	23
	Temperature Coefficient (%/°C)		0.0 - 9.9	3.0
	Year		-	Refer to certificate delivered with the detector
Internal Temperature (°C) (If type = internal) External Temperature (°C) (If type = external)		-	-	

MAINTENANCE				
Selection		Choice - Setting limit	Initial settings	
Detector		-	20	
Timers	Detector		-	
	Filament 1	Timer		-
		Reset Timer	Function launching	-
	Filament 2	Timer		-
		Reset Timer	Function launching	-
	Calibrated leak		-	To be set
	Cycle Counter	Cycle Counter		-
		Time interval		1·10 ⁺¹⁹ - 1
		Reset counter	Function launching	-
	Primary Pump (Wet / Dry Model)	Timer (h)		-
		Time interval (h)	Wet Model	0 - 99999
			Dry Model	0 - 99999
		Reset Timer	Function launching	-
	Secondary Pump 1	Timer (h)		-
		Time interval (h)		-
Reset Timer		Function launching	-	
Speed (rpm)		-		
Detector Information	Access to Detector general information		-	



MAINTENANCE					
Selection				Choice - Setting limit	Initial settings
Pump Information	Primary Pump 1	If Dry Model	Used	-	Yes
			Status	-	On
			Speed	-	Maxi
			Synchro	-	Yes
	If Wet / Integrable Model			-	Parameters not available
	Secondary Pump 1	Status	-	On	
		Rotation	-	Synchro	
Speed (rpm)		-	90000		
TMP information		Access to Pump general information	-	-	
Events History				-	Empty
Calibration History				-	Empty
Burn-in	Function launching			-	-
Maintenance Secondary Pump and Cell	Function launching			-	-

CONFIGURATION					
Selection				Choice - Setting limit	Initial settings
Unit/Date/Time/Language	Unit			mbar·l/s / Pa·m ³ /s / Torr·l/s / atm·cc/s / ppm / sccm / sccs	To set
	Date			mm/dd/yyyy	To set
	Time			hh:mm:ss	To set
	Language			English / French / German / Italian / Chinese / Japanese / Korean / Spanish / Russian	To set
Function keys	Setting			-	-
Application Windows	Standard Window Parameters	Bargraph leak rate	Zoom on Set Point	No / Yes	No
			Low Decade	1·10 ⁺⁵ - 1·10 ⁻¹³	1·10 ⁻¹²
			High Decade	1·10 ⁺⁰ - 1·10 ⁻¹²	1·10 ⁻²
		Stand-By Value		Hide / Show	Show
		Inlet Pressure		Hide / Show	Show
		Extra Pressure		Hide / Show	Hide
	Lower Display Limit		1·10 ⁺¹⁹ - 1·10 ⁻¹⁹	1·10 ⁻¹³	
	Standard	Access		-	Show
		Order		-	1 ^{er}
	Graph	Access		Hide / Show	Show
		Order (If Show)		2 nd - 4 th	2 nd
	Synoptique	Access		Hide / Show	Show
Order (If Show)		2 nd - 4 th	3 rd		
Settings	Access		Hide / Show	Show	
	Order (If Show)		2 nd - 4 th	4 th	



CONFIGURATION				
Selection		Choice - Setting limit	Initial settings	
Screen settings	Brightness		High / Low	
	Contrast		0 - 100	
	Panel Off		None / 15 min / 30 min / 1 h / 2 h / 4 h	
	Paging Function	Without RC 500 WL remote control detected	-	None
		With RC 500 WL remote control detected	Off / On	Off
	Reset panel parameters	Function launching	-	-
Access / Password	Password		0000 - 9999	
	Set Points Menu Access		Lock / Unlock	
	Test Menu Access		Lock / Unlock	
	Spectro Menu Access		Lock / Unlock	
	Maintenance Menu Access		Lock / Unlock	
	Configuration Menu Access		Lock / Unlock	
	Advanced Menu Access		Lock / Unlock	
	User Level		Restricted / Medium Access / Full Access	
	Change Password		0000 - 9999	

ADVANCED					
Selection		Choice - Setting limit	Initial settings		
Leak Detection	Start Up Timer		0 - 1 h		
	Background Suppression	Activation		Off / On	
		Crossover Pressures	Gross Leak	Wet / Dry Models	$2,5 \cdot 10^{+1} - 1 \cdot 10^{+1}$
	Integrable Model			$2,5 \cdot 10^{+1} - 5 \cdot 10^{-1}$	
	Normal		Wet / Dry Models	$5 \cdot 10^{-1} - 1 \cdot 10^{-1}$	
			Integrable Model	$5 \cdot 10^{-1} - 5 \cdot 10^{-2}$	
	Calibration	Calibration		Operator / Start-Up / Manual	
		Calibration checking	Checking		Operator / Automatic
			Frequency (If automatic)	Cycles	0 - 9999
	Hours	0 - 9999		10	
	Analyzer Cell	Filament Selected		1 / 2	
		Filament		Off / On	
		Triode Pression		-	
		Electric Zero		-	
Calibration Valve		-			
Target Value		-			
Acceleration Voltage (V)		-			
Emission (mA)		-			
Sensitivity Coefficient		-			
Internal Temperature (°C)		-			



ADVANCED Selection					Choice - Setting limit	Initial settings
Leak Detection	Internal Pirani Calibration	Function launching			-	-
	External Gauge	Gauge			None / TPR / PCR / Linear	None
		External Pressure (mbar)			-	-
		Pression Inlet Source			Internal / External	Internal
		Full scale (mbar) (if Linear)			0.1 - 50000	To set
	Purge Valve	If Dry Model			Automatic / Closed / Open	Automatic
		If Wet Model			-	Closed
		If Integrable Model			Closed / Open	Open
	Dynamic Calibration (Integrable Model)	Active			No / Yes	No
		Value			10^{+19} - 10^{-19}	$1 \cdot 10^{-7}$
Coefficient			-	1		
Input/Output (I/O 15 pins)	Serial link 1	Type			Serial	Serial
		Parameters	Mode		Basic / Spreadsheet / Advanced / Export. Data / RC 500 WL / PV Protocol / Ext. Module	Advanced
			Handshake		None / XON / XOFF	None
			Power Pin 9		-	5 V
	Serial link 2	Type			Not used / Bluetooth	Not used
		Parameters (If Bluetooth)	Mode		Basic / Spreadsheet / Advanced / Export. Data / PV Protocol	Advanced
			Handshake		None / XON / XOFF	None
	I/O Connector	Analog Output	9-gnd	Allocation	See Manual I/O 15 pins	Mantissa
				Value	According to Allocation	-
			10-gnd	Allocation	See Manual I/O 15 pins	Logarithmic
				Value	According to Allocation	10^{-12}
			12-gnd	Allocation	-	Exponent
				Value	10^{+2} - 10^{-13}	10^{-12}
	Input/Output (I/O 37 pins)	Serial link 1	Type			Serial / USB
Parameters			Mode		Basic / Spreadsheet / Advanced / Data export / RC 500 WL / PV Protocol / Module Ext.	Advanced
			Handshake		None / XON / XOFF	None
			Power Pin 9		-	5 V



ADVANCED Selection					Choice - Setting limit	Initial settings	
Input/Output (I/O 37 pins)	Serial link 2	Type			Not used / USB / Bluetooth / Network	USB	
		Parameters	Mode			Basic / Spreadsheet / Advanced / Export. Data / PV Protocol	Advanced
			Handshake			None / XON / XOFF	None
I/O Connector	Quick View	I/O set in the 37 pins connector					
		Analog output	37-gnd	Allocation	See Manual I/O 37 pins		Mantissa
	Value			According to allocation		-	
	36-gnd		Allocation	See Manual I/O 37 pins		Logarithmic	
			Value	According to allocation		10^{-12}	
	19-gnd		Allocation	-		Exponent	
			Value	$10^{+2} - 10^{-13}$		10^{-12}	
	Digital input	11-gnd	Allocation	See Manual I/O 37 pins		Inlet Vent	
			Activation	Rising edge / Falling edge / Impulsion		Rising edge	
		30-gnd	Allocation	See Manual I/O 37 pins		Zero	
			Activation	Rising edge / Falling edge / Impulsion		Rising edge	
		12-gnd	Allocation	See Manual I/O 37 pins		Calibration	
			Activation	Rising edge / Falling edge / Impulsion		Impulsion	
		31-gnd	Allocation	See Manual I/O 37 pins		Filament	
			Activation	Rising edge / Falling edge / Impulsion		Rising edge	
		13-gnd	Allocation	See Manual I/O 37 pins		HV test	
			Activation	Rising edge / Falling edge / Impulsion		Rising edge	
		32-gnd	Allocation	See Manual I/O 37 pins		Bypass option	
			Activation	Rising edge / Falling edge / Impulsion		Rising edge	



ADVANCED							
Selection					Choice - Setting limit	Initial settings	
Input/Output (I/O 37 pins)	I/O connector	Digital Transistor Output	9 - 28	Allocation	See Manual I/O 37 pins	Bypass	
				Activation	NO / NC	NO	
			8 - 27	Allocation	See Manual I/O 37 pins	Detector Ready	
				Activation	NO / NC	NO	
			7 - 26	Allocation	See Manual I/O 37 pins	Filament #2	
				Activation	NO / NC	NO	
		6 - 25	Allocation	See Manual I/O 37 pins	Warning/Error		
			Activation	NO / NC	NO		
		Digital Relay Output	5 - 24	Allocation	See Manual I/O 37 pins	GL Test	
				Activation	NO / NC	NO	
			4 - 23	Allocation	See Manual I/O 37 pins	N Test	
				Activation	NO / NC	NO	
			3 - 22	Allocation	See Manual I/O 37 pins	Filament on	
				Activation	NO / NC	NO	
			2 - 21	Allocation	See Manual I/O 37 pins	Reject point	
				Activation	NO / NC	NO	
		1 - 20	Allocation	See Manual I/O 37 pins	HV test		
			Activation	NO / NC	NO		
		Select Default Configuration	Function launching		-	-	
		Other Configurations				ASM 142 / ASM 182 / HLT 5xx	-
		Load Config. from SD Card	Function launching		-	-	
SD Card	Load LD Parameter	Function launching		-	-		
	Save LD Parameter	Function launching		-	-		
	Visualize *.BMP	Function launching		-	-		
SAV	Access to Menu Service with password. Only for Service Centers.						

7.3 Set points Menu

→ From the "Settings" screen, press **[Set points]** to access the menu.

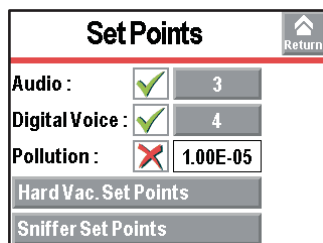

7.3.1 Audio alarm and digital voice

Audio alarm The audio alarm informs the operator that the reject set point has been crossed. The level varies from 0 to 8 (0 to 90 dB (A)).

From the "Settings" screen, press [Set points].

Audio	⇒ Activate the audio level.
	⇒ Set the audio level.



For quick access from the control panel, set a function key to [Audio] (see 7.7.2).

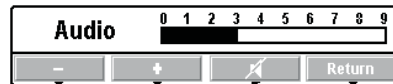

Fig. 19: "Audio" screen using a function key

Digital voice Digital voice informs the operator about the status of the detector or actions to be carried out.

From the "Settings" screen, press [Set points].

Digital voice	⇒ Activate digital voice.
	⇒ Set the digital voice level.



For quick access from the control panel, set a function key for [Voice] (see 7.7.2).

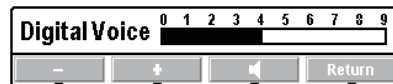

Fig. 20: "Voice" screen using a function key

"Mute" function → Stop the audio alarm and the digital voice at the same time with the [Mute].



To launch the function from the control panel, set a function key to [Mute] (see 7.7.2).

7.3.2 Pollution function

This is a safety device for the detector. It prevents too much leaked tracer gas from penetrating the detector. We recommend setting the pollution set point to a maximum of 4 decades above the reject set point. If the leak rate rapidly increases above the pollution set point, the cycle stops automatically and the leak detector returns to Stand-by mode.

From the "Settings" screen, press [Set points].

Pollution	⇒ Activate the function.
	⇒ Set the application set point.



Useful function if the part or installation to be tested is likely to have gross leaks.

7.3.3 Hard Vacuum reject point

The hard vacuum reject point defines the acceptance set point for parts that are "accepted/rejected" in a hard vacuum test:

- Measured leak rate ≤ reject set point: part accepted
- Measured leak rate > reject set point: part rejected

From the "Settings" screen, press [Set points] [Hard Vacuum set points].

Reject point	⇒ Set the reject point value.
Reject point #	4 additional reject points available with the 37 pin I/O board. ⇒ Set the set point value.

The reject set point is memorized for each configurable tracer gas.



For quick access from the control panel, set a function key for [Reject Point] (see 7.7.2).





Fig. 21: "Reject point" screen using a function key.

7.3.4 Sniffing reject set point

The sniffing reject set point defines the acceptance set point for parts that are "accepted/rejected" in a sniffing test:

- Measured leak rate ≤ reject set point: part accepted
- Measured leak rate > reject set point: part rejected.

From the "Settings" screen, press [Set Points] [Sniffing Set Points].

Reject point ⇒ Set the set point value.



For quick access from the control panel, set a function key for [Reject Set Point] (see 7.7.2) and (see 7.3.3).

7.3.5 Probe clogged set point

The purpose of this set point is to check that the sniffer probe (accessory) is operational. When the measured leak rate is lower than the set 'probe clogged' set point, the operator receives a message to check the probe (See **Sniffer probe Operating instructions**).

From the "Settings" screen, press [Set Points] [Sniffing Set Points].

Probe clogged ⇒ Set the set point value.

- With the Standard sniffer probe, the set point unit is the unit set for the detector.
 - With the Smart sniffer probe, the set point unit is always 'sccm'.
- ➔ Block the end of the sniffer probe from time to time with your finger to check that the leak rate is going down. If not, the probe may be clogged. Do not block the end for too long: if the measured leak rate decreases too much, there is risk of exiting the sniffing test.



7.4 “Test” Menu

→ From the "Settings" screen, press [Test].

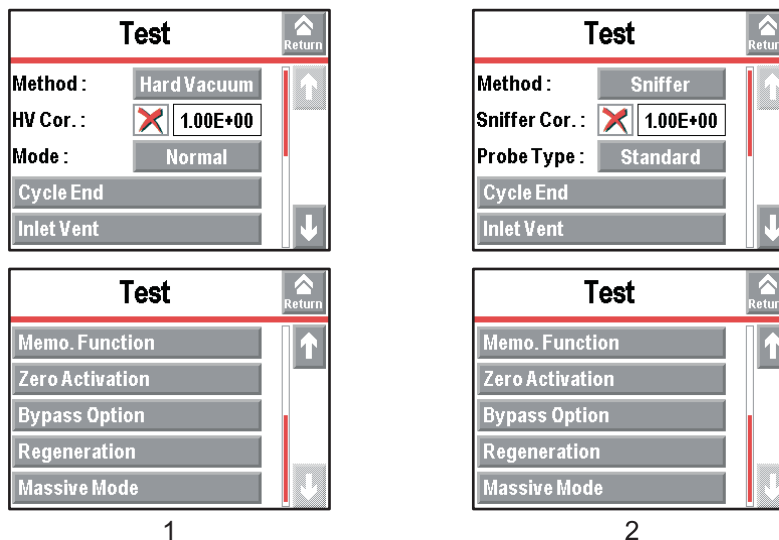

Fig. 22: Hard vacuum test 1 and sniffing test 2 menu

7.4.1 Test methods

There are 2 possible test methods (see 4.3):

- hard vacuum test,
- sniffing test.

From the "Settings" screen, press [Test].

Method	⇒ Select the test method. – For the hard vacuum test, set the test mode (see 7.4.3). – For the sniffing test, set the sniffing probe model used (see 7.4.4).
--------	--

Switching from 'Hard Vacuum test' to 'Sniffing test'

After modifying the settings, a transition duration of < 3 min during which the test can be performed but calibration is not possible.

Switching from 'Sniffing test' to 'Hard Vacuum test'

After modifying the settings, a transition duration of 30 s during which neither the test nor the calibration can be performed.



NOTICE

Limit of operation

→ Make sure that the parts or chambers connected to the inlet of our products withstand a negative pressure of $1 \cdot 10^3$ hPa in relation to atmospheric pressure.

For quick access from the control panel, set a function key for [Method] (see 7.7.2).



Fig. 23: "Method" screen using a function key



7.4.2 Correction factor

The correction factor allows correction of the measured leak rate by the detector when it is combined with parallel pumping.

From the "Settings" screen, press [Test].	
HV Correction/Sniff.	⇒ Activate the correction factor application.
Correction	⇒ Set the correction factor to be applied.



For quick access from the control panel, set a function key for [Correction] (see 7.7.2).

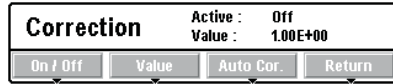

Fig. 24: "Correction" screen using a function key

Displays: digital and bargraph

Only the digital display is corrected by the correction factor: the correction factor does not apply to the bargraph display.



Depending on the concentration of tracer gas used for detecting leaks, the leak rate displayed changes.
 – Example: the leak rate displayed with a calibrated leak of $1 \cdot 10^{-8}$ Pa·m³/s ($1 \cdot 10^{-7}$ mbar·l/s) (with 100 % ⁴He) connected to the detector's inlet.

% He in the gas used	100 %	50 %	5 %	1%
leak rate displayed on the leak detector without correction	$1 \cdot 10^{-8}$ Pa·m ³ /s $1 \cdot 10^{-7}$ mbar·l/s	$5 \cdot 10^{-9}$ Pa·m ³ /s $5 \cdot 10^{-8}$ mbar·l/s	$5 \cdot 10^{-10}$ Pa·m ³ /s $5 \cdot 10^{-9}$ mbar·l/s	$1 \cdot 10^{-10}$ Pa·m ³ /s $1 \cdot 10^{-9}$ mbar·l/s
Correction value	1	2	20	100
Leak rate displayed on the leak detector with correction	$1 \cdot 10^{-8}$ Pa·m ³ /s $1 \cdot 10^{-7}$ mbar·l/s			

Integrable Model

The customer's external primary pump does not constitute a parallel pump. It does not necessitate a correction factor.

7.4.3 Test mode

A hard vacuum test can be performed as soon as one of the test modes is reached. The leak detector will automatically switch to the test mode selected when the internal pressure reaches the crossover threshold (see 7.8.4).



For quick access from the control panel, set a function key for [Mode] (see 7.7.2).



Fig. 25: "Mode" screen using a function key



By default, the leak detector is set to work in a hard vacuum test, in the most sensitive test mode: this setting meets the majority of the operators' needs.

From the "Settings" screen, press [Test].	
Mode	⇒ Set the test mode.

Integrable Model

Display of leak rate in Gross Leak test mode:

- Pressure test > 5 mbar:
 - Display bargraph only (measurements recorded if graph recording is in progress)
 - No digital display
- Pressure test < 5 mbar:
 - Bar graph and digital displays



7.4.4 Type of probe

A sniffer probe must be connected in order to work in sniffing.

2 models available: Standard probe and Smart probe, as an accessory (see 10).

From the "Settings" screen, press [Test].

Probe type	⇒ Set the probe model used.
------------	-----------------------------

See also Probe clogged set point (see 7.3.5).

Integrable Model

Make sure that the connected primary pump can be used with a Smart probe. (see 5.10.1)

7.4.5 Automatic Cycle End

This function allows automatic control of the roughing time and measurement time in a hard vacuum test.

From the "Settings" screen, press [Test] [Cycle End].

Automatic cycle end	⇒ Activate the function. Function activated if 'automatic' is set.
Roughing timer	Setting optional if 'automatic' is set. ⇒ Activate the control for the roughing duration. ⇒ Set the maximum roughing duration allowed. If the control is activated and the duration expires (detector still in roughing) = part rejected.
Test timer	Setting required if 'automatic' is set. ⇒ Set the measurement duration. When the duration expires, the measured leak rate is displayed.



Function to use to automate small production.

7.4.6 Inlet vent

This function allows an inlet vent after a hard vacuum test stop.

It allows the detector's inlet, and therefore the connected part or installation, to return to atmospheric pressure.

This function is secure: a confirmation message "Inlet vent? Please confirm." appears each time the operator requests an inlet vent.

From the "Settings" screen, press [Test] [Inlet vent].

Inlet vent	⇒ Activate the function. Function activated if 'automatic' is set.
Delay	Setting required if 'automatic' is set. ⇒ Set the delay. Delay = time between the test stop and the automatic opening of the inlet vent valve. Allows a controlled valve to be closed before inlet vent.
Vent Timer	Setting optional if 'automatic' is set. ⇒ Activate the closing of the inlet vent valve. ⇒ Set the duration. Duration = time between the opening of the air inlet valve and its automatic closing. The automatic closing after a set duration is used to limit consumption of dry air or nitrogen, if purge is connected.



For quick access from the control panel, set a function key for [Inlet Vent] (see 7.7.2).

Activate VENT ? Please confirm.

Ok

Return

Fig. 26: "Activate vent" screen using a function key

If "Automatic" is selected, air enters automatically when  is pressed to stop the test.

If 'Operator' is selected, press the corresponding function key to return the detector to atmospheric pressure.

Inlet vent manual activation from:

- the button **[Inlet vent]**
- the "Standard" screen (6) (see 6.1.4).



To lock the control for the inlet vent valve, delete the [Inlet vent] function key. The icon will stay on the "Standard" screen as an indicator but manual activation by the operator will be deactivated.



NOTICE

Automatic inlet vent
 Never programme 'automatic' inlet vent while the detector is connected to a high vacuum chamber or semi-conductor process chamber!
 Select 'Operator' and/or delete the function key allocated to the automatic inlet vent. The inlet vent must be carried out using the menu, which can be password locked.



By connecting an inlet vent (or nitrogen) line to the inlet vent, the detector's tracer gas pollution is reduced.

7.4.7 Memo function

This function freezes the "Standard" screen and displays the most recent test result: the leak rate displayed flashes.

From the "Settings" screen, press [Test] [Memo Function].

Active	⇒ Activate the function.
Display time	Setting required if the function is active. ⇒ Activate the display time delay. <ul style="list-style-type: none"> • On = the value of the measured leak rate flashes for the set duration. • Off = the value of the measured leak rate will flash until a new test begins. ⇒ Set the display duration.



For quick access from the control panel, set a function key for [Memo] (see 7.7.2).



Fig. 27: "Memo function" screen using a function key

7.4.8 Zero activation

This function is used to help the operator identify very small leak rate variations in the surrounding background or to dilate small measured leak rate fluctuations on the analogical display.

From the "Settings" screen, press [Test] [Zero Activation].

Activation	⇒ Activate the function (activated if 'automatic' is set).
Zero Exit	Setting required if 'operator' is set. ⇒ Set the type of keystroke for exiting the function (see below).
Trigger	Setting required if 'automatic' is set. ⇒ Set the function trigger factor.
Value	Setting required if 'automatic' is set. ⇒ Set the function trigger value.



To launch the function manually from the control panel, set a function key to [Zero] (see 7.7.2).

- To activate the function manually, press the **[Zero]**.
- Press once: activate/deactivate zero by quickly pressing the **[Zero]** function key.
- Press > 3 s:
 - activation: quickly press the **[Zero]** function key. Each time the key is pressed quickly, a new zero is carried out.



- deactivation: press > 3 s the **[Zero]** function key.



Using this function is recommended when the background of the tracer gas is stable and significant. This function is used to measure a leak rate that is lower :

- 2 decades in hard vacuum test mode $5 \cdot 10^{-13}$ Pa·m³/s ($5 \cdot 10^{-12}$ mbar·l/s) maximum
- 3 decades in sniffing mode ($5 \cdot 10^{-10}$ Pa·m³/s ($5 \cdot 10^{-9}$ mbar·l/s) maximum

than the detector's background when the detector is no longer in roughing.



To deactivate the Zéro [Zero] function key, set the activation to 'None'.

7.4.9 Bypass Option

Prerequisites:

- Detector with the 37 pin I/O board (option/accessory)
- Bypass kit (accessory) and its Bypass pump (at customer's expense), connected to the detector.

For more information about the Bypass and installing it on the leak detector, see the **Operating instructions** included with the kit.

→ From the "Settings" screen, press **[Advanced] [I/O Connector] [Quick View]** and check that the following inputs/outputs are set (initial settings):

- **Setting required for using the Bypass**
- Digital Input 32 – Ground = Bypass option
- Digital Transistor Output 9 – 28 = Bypass

→ If set otherwise, set like this: see **37 pin I/O board Operating instructions**.

Press [Test] [Bypass Option].

Mode	None = External Bypass pump installed but not active Quick pump = External Bypass pump active only during roughing Partial flow = External Bypass pump active during roughing and test + leak rate correction to be applied
Evac. Delay	On = roughing only via the external Bypass pump. Off = roughing via the external Bypass pump and the detector's primary pump (or primary pump of the client's setup for the Integrable model).

		1 st case	2 nd case	3 rd case	4 th case	5 th case
Pumping	Roughing	Primary Pump detector only ⁽²⁾	Bypass Pump external only	Bypass Pump external + Primary Pump detector	Bypass Pump external + Primary Pump detector ⁽²⁾	Bypass Pump external + Primary Pump detector ⁽²⁾
	Passage set point in gross leak test mode (by default 25 hPa for Wet and Dry models and 5 hPa for the Integrable model)					
	Test	Pumping Detector only ⁽³⁾	Pumping Detector only	Bypass Pump external + Pumping Detector ⁽¹⁾ ⁽³⁾	Pumping detector only	Bypass Pump external + Pumping Detector ⁽¹⁾ ⁽³⁾
Setting	Mode	No Bypass	Quick Pump	Partial Flow	Quick Pump	Partial Flow
	Evac. Delay	On/Off	On	on	Off	Off

(1) In this case, correcting leak rate to be applied

(2) or primary pump of the customer's setup for the Integrable model

(3) and primary pump of the customer's setup for the Integrable model

7.4.10 Regeneration

This function is used to remove the tracer gas from the detector by automatically carrying out a series of short tests and inlet vents between each test.



NOTICE

Before launching this function, make sure that the leak detector is in an environment free of tracer gas pollution.

- Check that the detector is on Stand-by and that inlet vent is 'automatic'.
- From the "Settings" screen, press **[Test] [Regeneration]**.
- Block the detector's inlet port with a blanked-off flange.
- Press **[Start]**: regeneration will stop automatically after 1 hour.
- To stop regeneration before the automatic stop time, press **[Stop]** in the menu or . Start a test ("Zero activation" function not activated) to check that the detector is no longer polluted.

At the end of the regeneration, the configuration of the inlet vent is identical to what it was before the regeneration.



This function is recommended when the detector's background is high or when the part or installation to be tested has high level of tracer gas.



To launch the function from the control panel, set a function key to [Regeneration] (see 7.7.2).

7.4.11 Massive mode

This mode allows the detector to carry out a test (⁴He only) on a very gross leak. The massive mode cannot be used if an external gauge is selected (see 7.8.8).

From the "Settings" screen, press [Test] [Massive Mode].	
Active	⇒ Activate massive mode.
Sensitivity	⇒ Select the sensitivity <ul style="list-style-type: none"> • High = test on large volume (initial setting, recommended). Low = test on volume < 1 l (if necessary).

When there is a very gross leak, the detector does not switch to Gross Leak mode and remains in roughing.

Function activated and pressure < 100 hPa, a message notifies the operator that the detector has switched automatically to massive mode: the detector can then perform a qualitative leak test (leak information > 5 Pa·m³/s (50 mbar·l/s only). The maximum use time is 55 minutes.



7.5 Spectro Menu

- From the "Settings" screen, press **[Spectro]**.



Spectro		Return
Tracer Gas :	Helium	
Fil. Selected :	#1	
Filament :	On	
Fil. Status :	100%	
Calibrated Leak		

7.5.1 Tracer gas

The tracer gas is the gas searched for during a test. 3 gases are available: ⁴He, ³He and H₂.

From the "Settings" screen, press [Spectro].
 Tracer gas ⇒ Select the tracer gas used.

The reject set point is stored for each configurable tracer gas.

Calibration

The leak detector should be calibrated with a calibrated leak of the same type as the tracer gas used.

Hydrogen test



DANGER

Explosion hazard.
 For detecting leaks with 'hydrogen' tracer gas, the operator must use hydrogenated nitrogen (mix of 95 % N₂ and 5 % H₂).

The detector's background is higher level of Hydrogen than Helium.

Typical H₂ background, during a test, when the detector is equipped with a blanked-off flange on the inlet port:

- at switching on :
 - low level ± 1·10⁻⁶ Pa·m³/s (1·10⁻⁵ mbar·l/s)
- after 2 or 3 hours:
 - low level ± 1·10⁻⁷ Pa·m³/s (1·10⁻⁶ mbar·l/s) for the Wet and Dry Models.
 - low level ± 2·10⁻⁷ Pa·m³/s (2·10⁻⁶ mbar·l/s) for the Integrable Model.



For quick access from the control panel, set a function key for [Tracer Gas] (see 7.7.2).



Fig. 28: "Tracer Gas" screen using a function key

7.5.2 Filament parameters

Fil. Selected	Indicates the filament used for the measurement (2 filaments in the analyzer cell).
Filament	Indicates if the filament used is 'on' or 'off' when the detector is switched on.
Fil. status	Indicator of analyzer cell performance. Initial settings: between 90 % and 100 % Normal operation: between 10 % and 100 % Normal wear on some cell components will reduce this value over time but will not reduce the accuracy of the detector's measurements.

7.5.3 Calibrated leak

For more information about calibrated leaks, see *the Maintenance instructions*.

From the "Settings" screen, press [Spectro][Calibrated leak].

Tracer gas	⇒ Set the tracer gas for the calibrated leak used for calibration.
Type	⇒ Define the type of calibrated leak used for calibration. <ul style="list-style-type: none"> • internal = calibration using the leak detector's internal calibrated leak (⁴He leak only). • external = calibration using an external calibrated leak (⁴He, ³He or H₂ leaks).
Unit	⇒ Set the calibrated leak unit used for calibration. ⁽¹⁾
Leak Value	⇒ Set the calibrated leak value used for calibration. ⁽¹⁾
Calibration valve	⇒ Define the actual status of the calibration valve. Used to open/close the manual calibration valve, for example. Remember to close the valve again after use. Manual calibration is only for experts.
Loss per Year (%)	⇒ Set the loss rate per year for the calibrated leak used for calibration. ⁽¹⁾



From the "Settings" screen, press [Spectro][Calibrated leak].

Ref. T. (°C)	⇒ Set the reference temperature for the calibrated leak used for calibration. ⁽¹⁾
Coeff. T. (%/°C)	⇒ Set the temperature coefficient for the calibrated leak used for calibration. ⁽¹⁾
Year	⇒ Set the month and year of calibration for the calibrated leak used for calibration. ⁽¹⁾
Internal T. (°C) or External T. (°C)	'Internal' indicates the temperature at the detector's internal calibrated leak. 'External' indicates the temperature at the detector's external calibrated leak.

(1) Use the information indicated on the calibrated leak used for calibration or on its calibration certificate.

In case of leak replacement, these parameters must be updated. When the parameters are saved, all the data from all the calibrated leaks set (1 internal leak and 3 external leaks) is memorised.

7.6 Maintenance Menu

→ From the "Settings" screen, press **[Maintenance]**.

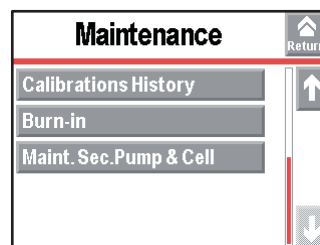
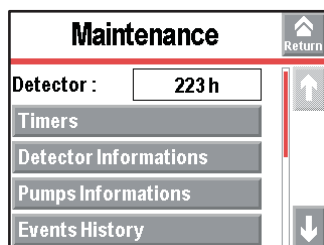

7.6.1 Detector

From the "Settings" screen, press [Maintenance].

Detector	Number of hours that the detector is switched on
----------	--

7.6.2 Timers

From the "Settings" screen, press [Maintenance] [Timers].

Detector	Number of hours that the detector is switched on.
Filament 1	Number of hours that filament 1 is on. ⇒ Press [xxx h] [Counter reset] to reset the counter.
Filament 2	Number of hours that filament 2 is on. ⇒ Press [xxx h] [Counter reset] to reset the counter.
Calib. Leak	Indicates the month and year of calibration for the calibrated leak used for calibration.
Cycle Counter	Indicates the number of performed cycles since the last reset / the set cycle number. When the set value is reached, an information message is displayed.
Prim. Pump	Wet / Dry Model Indicates the number of primary pump operating since the last reset / the set hour number. When the set value is reached, an information message is displayed. Integrable Model No available screen
Sec. Pump # 1	Indicates the number of secondary pump 1 operating since the last reset / the set hour number. When the set value is reached, an information message is displayed.



For quick access to the counters from the control panel, set a function key for [Maintenance] (see 7.7.2).

→ To set the set point and reset the cycle counter,

From the "Settings" screen, press [Maintenance] [Timers] [xxxx Cy/xxxx Cy].

Cycles	Indicates as a % the number of cycles made in relation to the interval set.
--------	---



From the "Settings" screen, press [Maintenance] [Timers] [xxxx Cy/xxxx Cy].

Counter	Indicates the number of cycles made since the latest reset of the counter.
Interval	⇒ Set the value for the counter. When the set value is reached, an information message is displayed.
Reset Counter	⇒ Press [Counter reset] to reset the counter.

➔ To set the set point and reset the operating hours counter for each pump's ,

From the "Settings" screen, press [Maintenance] [Timers] [xxxx h/xxxx h] for each pump.

Pump XXX	Indicates as a % the number of operating hours for the pump XXX in relation to the interval set.
Counter	Indicates the number of operating hours for the pump since the latest reset of the counter.
Time Interval	⇒ Set the value for the counter. When the set value is reached, an information message is displayed.
Reset Counter	⇒ Press [Counter reset] to reset the counter.

Primary pump: AMD1 (Dry Model) or RVP 1015 (Wet Model) pumps.
Secondary pump 1: Splitflow 50 pump.

7.6.3 Detector Information

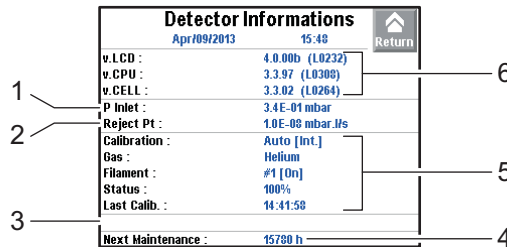

Fig. 29: Detector Information

1	Inlet pressure
2	Reject set point for the test method in progress
3	List of activated functions
4	Primary or secondary pump maintenance
5	Calibration information
6	Detector firmware information



For quick access from the control panel, set a function key for [Infor.] (see 7.7.2).

7.6.4 Pump Information

Primary Pump #1

From the "Settings" screen, press [Maintenance] [Pump Information] [Prim. Pump #1].

Used	Control of the pump by the detector
Status	Status of the pump
Speed	Pump status: Max/Min/Nominal
Synchro	Pump at the speed indicated in the firmware

No pump information for the Wet and Integrable Models: the message "No parameter available" is displayed.

Secondary Pump #1

From the "Settings" screen, press [Maintenance] [Pump Information] [Sec. Pump #1].

Status	Control of the pump by the detector
Rotation	Pump status: Synchro/Down/Fail/Running/Ram up
Speed (rpm)	Pump running speed : <ul style="list-style-type: none"> ● Hard Vacuum test = 90000 ● Sniffing test = 60000

➔ For more information about secondary pump #1, press **[TMP Information]**.



TMP Informations		Return
Turbo molecular pump		
Rot. Speed :	1500 Hz / 90000 rpm	
Voltage :	23.63 V	Synchro : OK
Power :	17 W	TC type : TC 110
Current :	0.75 A	TC Software : 012099
Temperatures		
T° Electronic :	48 °C	T° Bottom : 40 °C
T° Bearing :	40 °C	T° Motor : 44 °C
Days in maintenance		
1009 h / 16000 h		
Warning		
None		

7.6.5 Event history

Event history records the last 30 events. Beyond 30, the oldest recorded event will be replaced by the most recent, and so on.

→ From the "Settings" screen, press **[Maintenance] [Event History]**.

Events History		Return
Events:1		
1	I313 08/04/13 00:08 Date/Time updat	Export
2	I320 01/01/13 00:02 Int. Pirani Calib	↑
3		↓
4		

1	Exporting the history in .csv format to the SD card
2	RS-232 code for the event
3	Date - Time of the event
4	Description of the event

Event = Error (Exxx) or Warning (Wxxx) or Event (Ixxx)

List of errors and warnings: see **List of warnings/faults** in *Maintenance instructions*.

List of events:

RS-232 Code	Event	Description
I300	Inlet vent	Inlet vent
I301	Stp on pollution	Test stops automatically if leak rate pollution > Pollution
I302	RVP ctr reset	Primary pump hour counter reset.
I303	TMP1 ctr reset	Secondary pump 1 hour counter reset
I304	TMP2 ctr reset	Secondary pump 2 hour counter reset
I305	TMP3 ctr reset	Secondary pump 3 hour counter reset
I306	Fil 1 ctr reset	Filament 1 hour counter reset
I307	Fil 2 ctr reset	Filament 2 hour counter reset
I308	Cycle ctr reset	Cycle counter reset
I310	Autocal restart	Automatic start of a new autocalibration
I313	Date/Time up - Date	Date or time modification
I318	Full param reset	Detector parameters completely reset
I319	Fil change	Filament change (manually or automatically from Maintenance menu)
I320	Int. Pirani Calib.	Automatic internal Pirani gauge calibration
I321	Storage delay	Detector switched off for 15 days (minimum)

7.6.6 Calibration history

The calibration history records the last 20 calibrations made. Beyond 20, the oldest recorded calibration will be replaced by the most recent and so on.

→ From the "Settings" screen, press **[Maintenance] [Calibration History]**.

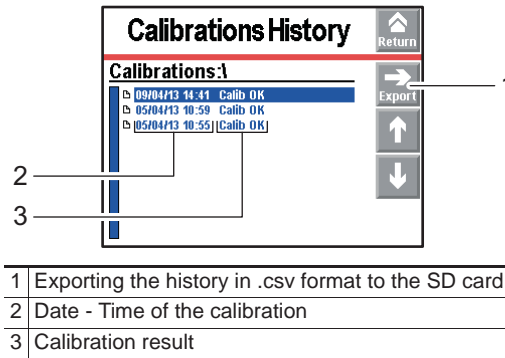

7.6.7 Burn-in

This function is used to prepare the detector, leaving it in optimal working condition by automatically carrying out a series of short tests and inlet vents between each test.



NOTICE

Before launching this function, make sure that the leak detector is in an environment free of tracer gas pollution.

- Check that the detector is on Stand-by and that inlet vent is 'automatic'.
- From the "Settings" screen, press **[Maintenance] [Burn-in]**.
- Block the detector's inlet port with a blanked-off flange.
- Press **[Start without calib.]** or **[Start with calib.]**: burn-in does not stop automatically.
 - **[Start without calib.]** = series of tests and inlet vents
 - **[Start with calib.]** = series of tests, inlet vents and calibrations (not available for sniffing test)
- To stop burn-in, press **[Stop]** on the menu or .

7.6.8 Maintenance for the analyzer cell and the secondary pump

To carry out maintenance on the secondary pump or the analyzer cell, the vacuum part of the detector must be at atmospheric pressure. This function is used to shut down the secondary pump and to perform an inlet vent so that the secondary pump and the analyzer cell are at atmospheric pressure.

- From the "Settings" screen, press **[Maintenance] [Maint.Sec. Pump & Cell]**.
- Press **[Stop & Vent]** to start the function.
 - The secondary pump slows to a speed that allows inlet vent.
 - A message notifies the operator when the leak detector can be shut down.
- Optional: to carry out an additional inlet vent before shutting down the detector, press **[Stop&Vent]**.
- If the operator does not want to shut down the detector, press **[Restart detector]**: the detector start-up screen is displayed.
- Shut down the detector, wait until the control panel turns off completely and unplug the electric power cable before working on the detector.

7.7 Configuration Menu

- From the "Settings" screen, press **[Config.]**.



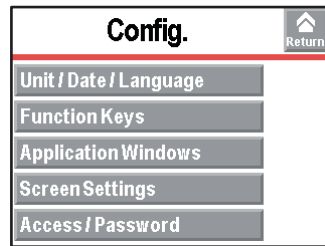

7.7.1 Time - Date - Unit - Language

The update of these parameters is automatically requested when the operator switches the detector on for the first time: after this, the operator can modify them at any time.

From the "Settings" screen, press [Config.] [Unit/Date/Language].

Unit	⇒ Set the unit to be used. The set points/values set are not automatically converted to the new unit if the unit changes: they must be updated by the operator.
Date	⇒ Set the current date.
Time	⇒ Set the time. The time is not automatically updated when switching from summer time to winter time and vice versa: it must be updated by the operator.
Language	⇒ Set the language.

7.7.2 Function keys

The function keys are used to activate/stop a function or to adjust set points.

Per initial settings, the 8 function keys are allocated and distributed over 2 levels: they can be reallocated by the operator.

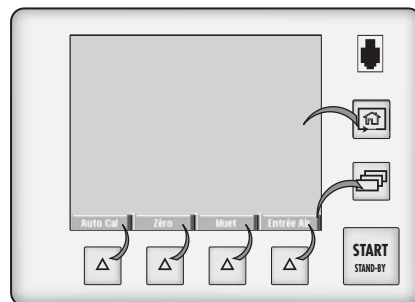

Fig. 30: Function keys

Allocating function keys

→ From the "Settings" screen, press [Config.] [Function Keys].



Thanks to the function keys, it is possible to give the operator access to a limited number of functions and to use a password to lock unauthorised functions on the "Settings" menu. They are sufficient to manage the detector.

→ To allow the operator to use only the [Start/Stand-by] key, do not allocate a function to the function keys and lock the "Settings" menu.

→ Up to 4 additional function keys can be added, for a maximum of 12. In this case, a 3rd level is made available to the operator.

Each function key can be allocated to a function chosen by the operator: see the example below.

Example: Allocate the 'Correction' function (1) to the [Mode] function key (2).

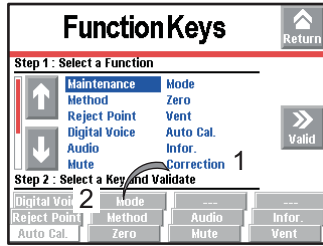

Fig. 31: Allocation objective

→ Select the 'Correction' function (1) using the and .

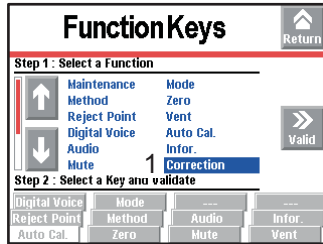

Fig. 32: Selecting the function

→ Select the [Mode] function key (2) by pressing repeatedly (key selected if background is white).

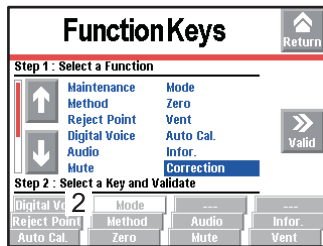

Fig. 33: Selecting the function key

→ Validate the settings (3): the function key (2) is now allocated to the [Correction] function.

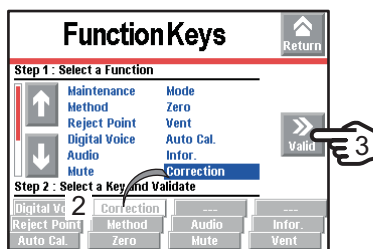



Fig. 34: Result of the allocation

7.7.3 Application screens

→ From the "Settings" screen, press [Config.][Application Windows].

By pressing repeatedly on the key , the various screens available appear (see 6.1.3).

The operator can hide one or more screen or switch the order in which they appear. The "Standard" application screen is always available in 1st position.



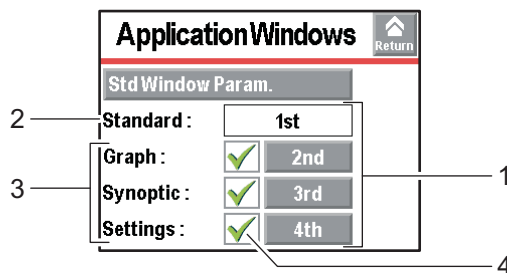

1	Order of the displayed screens with the key	
2	"Standard" application screen always displayed	
3	Available screens	
4	Displaying/hiding the application screen	

The screen order can be modified: press the order number (example: [3rd]) and use the **+** and **-** keys to choose the new order number then confirm.

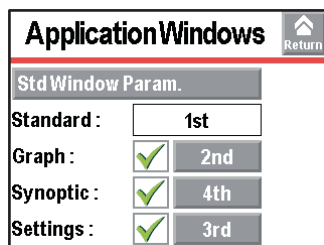

Fig. 35: The "Synoptic" screen order has switched from 3 to 4

When a screen is no longer selected or if its order has been changed, the general order is automatically updated.

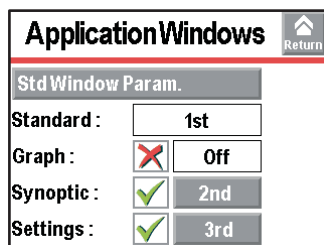

Fig. 36: The "Graph" screen is no longer available

When a screen is selected again, it automatically moves to last place.

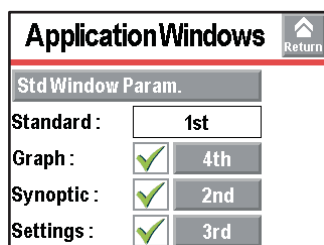

Fig. 37: The "Graph" screen is available again, and in last place.

Setting the "Standard" screen

From the "Settings" screen, press [Config.] [Application Windows] [Std Window Parameters].

Std-By Value	⇒ Display/Hide the leak rate display in Stand-by mode.
Inlet Pressure	⇒ Display/Hide the inlet pressure display.
Extra Pressure	⇒ Display/Hide the pressure display of for the cell or an external gauge. The external gauge (at the customer's expense) is a gauge installed on the customer's application, connected to the 37 pin I/O board.

From the "Settings" screen, press [Config.] [Application Windows] [Std Window Parameters].

Lower Display Limit	⇒ Set the minimum value displayed for leak rate. Leak rate not displayed if the value is less than the 'Lower Display Limit' configured value.
---------------------	---

From the "Settings" screen, press [Config.] [Application Windows] [Std. Window Parameters] [Leak Rate Bargraph].

Zoom on set point	⇒ Activate zoom to set point. Zoom to set point is used to display on the bargraph the reject set point centred on 2 decades.
Low Decade	⇒ Set the low decade for the bargraph display.
High Decade	⇒ Set the high decade for the bargraph display.

7.7.4 Screen Settings

From the "Settings" screen, press [Config.] [Screen Settings].

Brightness	⇒ Set the brightness.
Contrast	⇒ Set the contrast.
Panel off	⇒ Activate the sleep mode screen. The screen is in sleep mode when the back light goes off (black screen). The device appears to be off, but this is not the case! Simply touching the screen reactivates the display. By default, automatic sleep mode is not activated. If the screen is out of order, its functions are still accessible: use the RS-232 to manage/set the detector.
Paging Func.	⇒ Activate the Paging function. When a RC 500 WL remote control (accessory) is used, the 'Paging' function makes it possible to easily find the remote if it is located within its field of use with the detector. When the function is activated, the remote emits a sound signal so it can be located. To stop the sound signal, deactivate the Paging function.

→ Press [Reset Panel Param.] to reset the control panel parameters.



7.7.5 Access - Password

→ From the "Settings" screen, press [Config.] [Access/Password].

→ Enter the password ('5555' by default) and validate.

Menu access

The operator can lock access to one or more menus on the "Settings" screen. To access a locked menu, the operator will be asked to provide the password.

- Lock a menu by pressing .
- Unlock a menu by pressing .

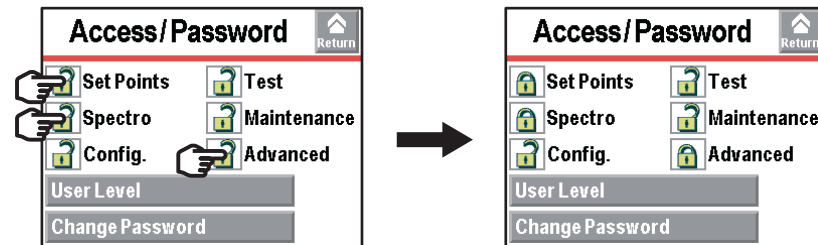

Fig. 38: Example: Locking the Set Points, Spectro and Advanced menus

On the "Settings" screen, the locked menus are indicated by .



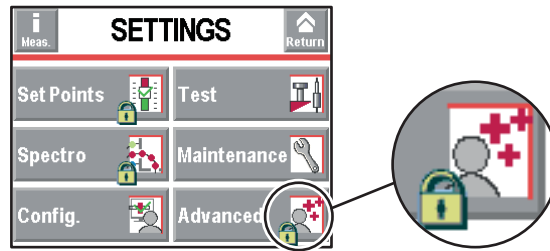

Fig. 39: Locked menus



- Change password**
- From the "Settings" screen, press **[Config.] [Access/Password]**.
 - Enter the password ('5555' by default) and validate.
 - Press **[Change Password]**.
 - Enter the new password and validate.

- User level**
- From the "Settings" screen, press **[Config.] [Access/Password] [User level]**.
- 3 user levels can be used to restrict the display and operator access to settings and functions:
- restricted access,
 - medium access,
 - full access.



If the password is forgotten, it can be found using the RS-232: see operating instructions.

Limits with Restricted access

- Key  invalid: no settings can be made without password.
- Pictogram  invalid.
- Function keys hidden.
- Inlet pressure and cell pressure hidden.
- Key  invalid: launch of a test via a communication interface only.
- Measured leak rate and reject set point displayed only in test.

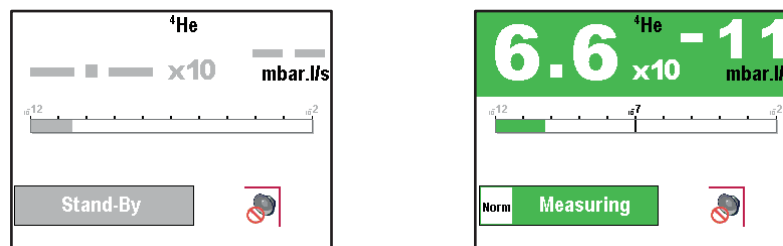



Fig. 40: Displays with Restricted access



With Medium or Restricted access, the operator can temporarily access the 6 menus on the "Settings" screen to set parameters.

- Press and hold the key  until the "Settings" screen is displayed with all the locked menus.
- Press the desired menu.
- Enter the current password ('5555' by default) and validate.
- Carry out the desired parameter settings.



Limits with Medium access

- Key  invalid: no settings can be made without password.
- 2 function keys available: **[Basic Param.]** and **[Info.]**.

Basic Param		Return
Hard Vac. Set Points :	1.00E-07 mbar.l/s	
Sniffer Set Points :	1.00E-06 mbar.l/s	
Method :	Hard Vacuum	
Mode :	Normal	
Gas :	Helium 4	
P Inlet :	2.2E-03 mbar	

Detector Information		Return
Jan/02/2013 19:18		
v.LCD :	4.0.00d (L0343)	
v.CPU :	3.3.99 (L0309)	
v.CELL :	3.3.02 (L0264)	
P Inlet :	3.5E-03 mbar	
Reject Pt :	1.0E-07 mbar.l/s	
Calibration :	Auto [Int.]	
Gas :	Helium 4	
Filament :	#1 [On]	
Status :	100%	
Last Calib. :	18:53:17	
Next Maintenance :	14990 h	

- Function keys hidden.
- Inlet pressure and cell pressure hidden.
- Key  valid.
- Measured leak rate and reject set point displayed only in test.

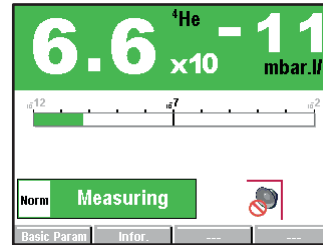
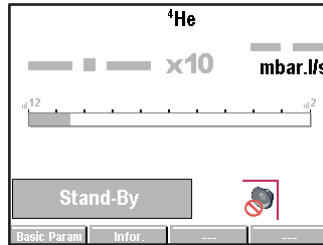



Fig. 41: Displays with Medium access



With Medium or Restricted access, the operator can temporarily access the 6 menus on the "Settings" screen to set parameters.

- ➔ Press and hold the key  until the "Settings" screen is displayed with all the locked menus.
- ➔ Press the desired menu.
- ➔ Enter the current password ('5555' by default) and validate.
- ➔ Carry out the desired parameter settings.

Limits with Full access

- No limit.

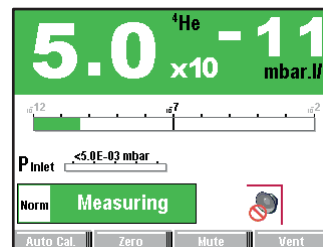
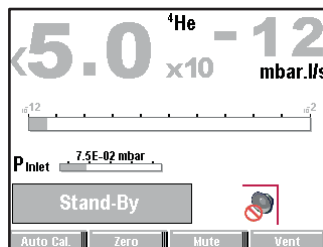



Fig. 42: Displays with Full access

Operator with Restricted or Medium access changing the access level.

- ➔ Press  until the "Settings" screen is displayed with all the locked menus.
- ➔ Press **[Config.]**.
- ➔ Enter the current password ('5555' by default) and validate.
- ➔ Press **[Access/Password]**.



- Enter the current password ('5555' by default) and validate.
- Press **[User Level]**.
- Change the access level: see below the limits for each level.

Operator with Full access changing the access level.

- From the "Settings" screen, press **[Config.] [Access/Password]**.
- Enter the current password ('5555' by default) and validate.
- Press **[User Level]**.
- Change the access level: see below the limits for each level.

7.8 Advanced Menu

The Advanced menu is reserved for leak detection experts and/or for setting a particular product.

- From the "Settings" screen, press **[Advanced]**.

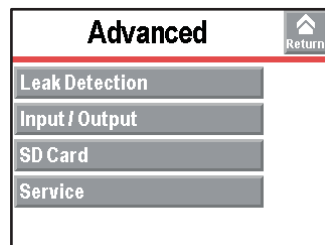

7.8.1 Leak Detection Menu

- From the "Settings" screen, press **[Advanced] [Leak Detection]**.

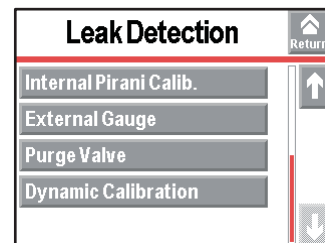
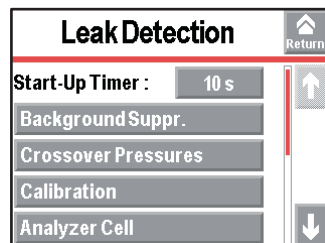

7.8.2 Leak Detection: Start-up timer

The start-up timer prevents the leak detector from being used for a pre-determined duration after it has been switched on. This means measurements cannot be made until the leak detector is thermically stabilized, or while traces of tracer gas remain in the detector.

From the "Settings" screen, press [Advanced][Leak Detection].

Start-up timer	⇒ Set the start-up timer.
----------------	---------------------------

7.8.3 Leak detection: Background suppression

This function is used to suppress the detector's background.

From the "Settings" screen, press [Advanced] [Leak Detection] [Background Suppr.].

Activation	⇒ Activate the function ('on' if activated).
------------	--

Note: after calibration, with background suppression function activated, the leak detector's background will be lower than $5 \cdot 10^{-13} \text{ Pa} \cdot \text{m}^3/\text{s}$ ($5 \cdot 10^{-12} \text{ mbar} \cdot \text{l/s}$).



This function is recommended for testing very small leaks, which improves measurement and reading. This function can be used to measure a leak rate 2 decades lower than the detector's background, when the detector is no longer in roughing.

7.8.4 Leak Detection: Crossover Pressures

In a hard vacuum test, used to define the crossover pressures in the different test modes.

From the "Settings" screen, press [Advanced] [Leak Detection] [Crossover pressures].	
Gross Leak	⇒ Set the cross over from Roughing to Gross Leak mode.
Normal	⇒ Set the cross over from Gross Leak mode to Normal mode.

7.8.5 Leak Detection: Calibration



NOTICE

Detector calibration

When switched on, the detector suggests that the operator carry out an auto-calibration (if calibration parameter = 'operator'). For the optimal use of the detector, **this auto-calibration must be performed**. In all situations, a manual or automatic calibration must be performed:

- at least once a day
- to optimise the measurement reliability for high sensitivity tests
- if it is uncertain whether the detector is working properly
- during intense and continuous operation: start an internal calibration at the beginning of each work session (e.g. work in teams, every 8 hours).

Calibration makes it possible to verify that the detector is properly adjusted to detect the selected tracer gas and display the correct leak rate value.

From the "Settings" screen, press [Advanced] [Leak Detection] [Calibration].	
Calibration	⇒ Select the type of calibration. See details below.
Calib.Checking	⇒ Activate the calibration checking and set the frequency. See details below.

If there is no internal calibrated leak, calibration can be performed with an external calibrated leak. By default, autocalibration is set to 'On' and the internal leak is selected so that the detector can be calibrated quickly.

Calibration = 'operator'

Calibration started by the operator.

→ Press the [AUTOCAL].

If calibration does not start within 20 minutes after the leak detector is switched on, message is displayed.

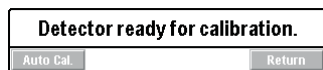

Fig. 43: Leak detector ready for calibration

Calibration = 'start-up'

Calibration starts automatically when the leak detector is switched on.

Calibration = 'manual'

Calibration starts manually.

Operation reserved for service centres and experts only.

The leak detector can also be calibrated using an external leak (see **Calibration in the Maintenance instructions**).

"Calibration control" setting

Calibration control saves the operator time because the calibration control is quicker than the full calibration.



If calibration = 'operator' or 'start-up', the calibration control function performs a control of the calibration according to the parameters set.

The calibration control is deactivated if calibration = 'manual'.

The calibration control is performed with the leak detector's internal calibrated leak (leak type parameter = 'internal').

The leak detector compares the measured leak rate of the internal calibrated leak with the set leak rate of the internal calibrated leak:

- If the ratio is within the limits allowed, the leak detector is properly calibrated.
- If the ratio is outside those limits, a message appears suggesting that a full calibration of the leak detector be started.

Checking	⇒ Select the type of calibration (activated if 'automatic' has been set).
Frequency	⇒ Set the set points (cycles and times) for triggering the calibration control. The first set point reached will trigger the control.



To launch the function from the control panel, set a function key to [Check Cal].



At any time, the operator can start a leak detector calibration control: detector in Stand-by mode, press the [AUTO CAL] function key twice within 5 seconds.

7.8.6 Leak detection: Analyzer cell

From the "Settings" screen, press [Advanced] [Leak Detection] [Analyzer Cell].

Fil. Selected	Indicates the filament used for the measurement (2 filaments in the analyzer cell).
Filament	Indicates if the filament used is 'on' or 'off' when the detector is switched on.
<ul style="list-style-type: none"> - Triode pressure - Elec.Zero - Target value - Acc. voltage (V) - Emission (mA) - Coeff. Sens. 	Parameters for manual calibration. This type of calibration is reserved for service centres and leak detection experts only.
Calib. valve	⇒ Define the actual status of the calibration valve. Used to open/close manually the calibration valve, for example. Remember to close the valve again after use. Manual calibration is only for experts.
Internal T (°C) or External T (°C)	'Internal' indicates the temperature at the detector's internal calibrated leak. 'External' indicates the temperature at the detector's external calibrated leak.



Do not switch off the filament except for carrying out manual calibration. It is not necessary to switch the filament off in Stand-by mode to save it.

- The leak detector switches automatically from one filament to the other if the selected filament currently being used becomes defective.
- When switched on, the leak detector uses the filament that was selected when it was shut down.

7.8.7 Leak Detection: Internal Pirani gauge calibration

Procedure → From the "Settings" screen, press **[Advanced] [Leak Detection] [Internal Pirani Calib.]**.

→ Block the detector's inlet with a blanked-off flange.

→ Make sure:

- that the leak detector is in a hard vacuum test, in the most sensitive test mode.
- that the end of the cycle is manual (= 'operator').

The calibration takes place in 2 stages: setting the limit pressure and setting the atmospheric pressure.

Setting the limit pressure

→ Make sure that the internal pressure is significantly lower than $1 \cdot 10^{-3}$ hPa.

→ Start a test: press  .



Setting the atmospheric pressure

- The "Pressure" value decreases: wait for this value to stabilise (around 5 minutes) and press the [**>HV**].
- Stop the test: press the  .
- Create an inlet vent: press [**Inlet vent**].
- Make sure that the detector is at atmospheric pressure.
- The "Pressure" value increases: wait for this value to stabilise (around 5 minutes) and press the [**>Atm**].

7.8.8 Leak Detection: External gauge

Allows the leak detector to be managed by an external gauge.

Prerequisites

- Detector equipped with the 37 pin I/O board (see 10).
- Deactivate the Massive mode to use an external gauge Massive Mode (see 7.4.11).
- Configure the pressure source of the pump inlet (= 'external').

Possible gauges

		Type of gauge detected by the detecto	Gauge model
Linear gauges	Capacitives	Linear	CMRxxx
	Piezo	Linear	APRxxx
Logarithmic gauges	Pirani	TPR/PCR	TPRxxx
	Capacitives Pirani	TPR/PCR	PCRxxx

- 3 cables (3 m, 10 m and 20 m) available for purchase (see 10).
- The gauge and the cable are the client's responsibility

Settings

From the "Settings" screen, press [Advanced] [Leak Detection] [External Gauge].

Gauge	⇒ Select the external gauge model.
Ext. Pressure (mbar)	Indicates the pressure measured by the external gauge.
Inlet Press. source	⇒ Set the inlet pressure displayed on the "Standard" screen: 'internal' (leak detector's internal gauge) or 'external' (external gauge on the customer's installation)
Full scale (mbar)	Only for a linear gauge
	⇒ Set the operating range for the gauge: value indicated on the gauge.

7.8.9 Leak Detection: Purge valve



NOTICE

For a global test of the leak detector, this valve must be closed.

Dry Model only

The purge valve prevents the detector from becoming polluted thanks to a continuous air flow inside the vacuum part of the detector.

From the "Settings" screen, press [Advanced] [Leak Detection] [Purge Valve].

Purge Valve	⇒ Set the status of the valve: <ul style="list-style-type: none"> • Automatic = valve opening/closing defined in the detector's supervisory firmware (Wet and Dry Model only) • Closed = valve always closed (1) • Open = valve always open (1)
-------------	--

(1) Temporary Opening/Closing managed by the supervisory firmware if necessary, then return to the set status.

7.8.10 Leak detection: Dynamic calibration

This function allows predictive adjustment of the leak rate for repetitive tests where the test time has to be optimised.

The adjustment is made via the RS-232 or logic inputs.





NOTICE

This function provides an adjustment and should not be confused with the correction coefficient. This coefficient complements the correction coefficient.

From the "Settings" screen, press [Advanced] [Leak Detection] [Dynamic calibration].

Active	⇒ Activate the dynamic calibration
Value	⇒ Set the target value to reach (leak rate value of the installation to calibrate)
Coefficient	Coefficient value calculated during dynamic calibration (Coefficient applied if dynamic calibration is activated)

Preliminary conditions

- Perform leak detector autocalibration.
- Activate the correction factor (see 7.4.2) and set it.
- Activate the dynamic calibration.
- Set the target value.
- Allocate the logic inputs (see **37-pin I/O Operating instructions**) or connect the RS-232 link.

	Logic input	RS-232 command
Start/Stop dynamic calibration coefficient calculation	Dynamic cal.	Start: =CDC Stop: =CDS
Start/Stop Test	HV test	Start: =CYE Stop: =CYD
Start/Stop Memo function	He memo	Start: =MEE Stop: =MED

Setting procedure for one test

- Implement the preliminary conditions.
- Activate the dynamic calibration coefficient calculation.
- Start a test.
- Activate the Memo function (logic input or RS). The new coefficient is automatically calculated and saved.

The calculated coefficient corresponds to the following ratio:

$$\text{coefficient} = \frac{\text{target value}}{\text{value of the leak rate displayed to adjust}}$$

The calculated coefficient must be between 0.5 and 3 inclusive. If not, an error message is displayed.

- Stop the test and deactivate the Memo function (logic input or RS).
- Stop the dynamic calibration coefficient calculation.

Example:

Target value = $1.0 \cdot 10^{-7}$

Value of the leak rate displayed to adjust: $5.0 \cdot 10^{-8}$

$$\text{coefficient} = \frac{1.0 \cdot 10^{-7}}{5.0 \cdot 10^{-8}} = 2$$

As 2 is between 0.5 and 3, the coefficient is correct.

Setting procedure for several tests

Several tests can be run to calculate the dynamic calibration coefficient. This allows the coefficient value to be fine-tuned.

- Implement the preliminary conditions.
- Activate the dynamic calibration coefficient calculation.
- Run the 1st test.
- Activate the Memo function (logic input or RS). The new coefficient is automatically calculated and saved.

The 1st coefficient calculated for the 1st test corresponds to the following ratio:

$$1^{\text{st}} \text{ coefficient (Coef 1)} = \frac{\text{target value}}{\text{value of the leak rate displayed to adjust}}$$

value of the leak rate of the 1st test

The calculated coefficient must be between 0.5 and 3 inclusive. If not, an error message is displayed.

- Stop the test and deactivate the Memo function (logic input or RS).
- Repeat the last 3 operations n number of times:
 - Run a test
 - Activate the Memo function
 - Stop the test and deactivate the Memo function

The calculated and memorised coefficient is readjusted after each test, as in:

$$\text{coefficient} = \frac{\text{Coef 1} + \text{Coef 2} + \text{etc.} + \text{Coef n}}{n}$$

- Stop the dynamic calibration coefficient calculation.



NOTICE

Коэффициент будет продолжать корректироваться после каждого теста пока расчет коэффициента динамической калибровки не остановлен.

7.8.11 Input/Output menu

- From the "Settings" screen, press **[Advanced]** **[Input/Output]**.

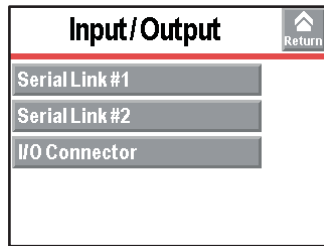

7.8.12 Input/Output: Serial Link 1 and Serial Link 2

From the "Settings" screen, press **[Advanced]** **[Input/Output]**, then **[Serial Link 1]** or **[Serial Link 2]**.

Type	⇒ Set the type of serial link: see table below.
Parameters	⇒ Set the serial link mode: see detail below.

The operator must allocate the 2 serial links (1 and 2) according to their use.

Use	Possible allocation		Type to select
	Serial Link 1	Serial Link 2	
RS-232	yes	no	Serial
Bluetooth ⁽¹⁾	no	yes	Bluetooth
USB ⁽²⁾	yes	yes	USB
Wi-Fi ⁽³⁾	no	yes	Network
Ethernet ⁽⁴⁾	no	yes	Network
RC 500 WL remote ⁽⁵⁾	yes	no	Serial

- (1) Option or accessory
- (2) With all I/O boards (option or accessory)
- (3) With I/O Wi-Fi board (option or accessory)
- (4) With I/O Ethernet board (option or accessory)
- (5) Accessory

- Parameters** → From the "Settings" screen, press **[Advanced]** **[Input/Output]** **[Serial Link 1]** or **[Serial Link 2]****[Parameters]**.



Mode	Description	Use ⁽¹⁾		
		RS-232	Blue-tooth	USB / Wi-Fi / Ethernet
Basic	Continuous acquisition of data sent to the hyperterminal according to a defined time duration. At any time, a command can be sent to the leak detector. Recommended mode during leak detector test procedure setting operations.	x	x	x
Spreadsheet	Variant on the Basic mode. Continuous data acquisition, formatted in a spreadsheet such as Excel Microsoft® Office or other similar software. Recommended mode for drawing graphs.	x	x	x
Advanced	Full control of the detector by a supervisor. The detector sends information at the supervisor's request. 5 V power supply available. Recommended mode for automatic systems.	x	x	x
Export Data	Export, via a PC, of "tickets" issued by the detector after: <ul style="list-style-type: none"> • Calibration with an internal/external calibrated leak, • Calibration control with an internal leak, • A test. Serial links 1 and 2 must not be in "Export Data" mode at the same time.	x	x	x
RC 500 WL	Use of a wireless remote control (model RC 500 WL). ⁽¹⁾	x	x	-
PV Protocol	Protocol for compatibility with the HLTxxx detector protocol. List of orders for the protocol compatible with ASM 340. <i>See the RS-232 operating instructions).</i>	x	x	x
Ext. Module	Full control of the detector by a supervisor. The detector sends information at the supervisor's request. 24 V power supply available. A 24 V power supply is required for using an external module (example: profibus).	x	-	-

(1) See Standard Remote Control Operating instructions for more details.

7.8.13 Input/Output: I/O connector

→ A partir de l'écran «Réglages», appuyer sur **[Avancé] [Entrée/Sortie] [Connecteur E/S]**.

Le détecteur est équipé :

- soit d'une interface E/S 15 points (*voir Manuel de l'utilisateur de la carte E/S 15 points*).
- soit d'une interface E/S 37 points (*voir Manuel de l'utilisateur de la carte E/S 37 points*).

7.8.14 SD Card menu

From the "Settings" screen, press [Advanced] [SD card].

Load Detector Param.	⇒ Load the saved parameters onto the SD card.
Save Detector Param.	⇒ Save the leak detector parameters to the SD card.
View * BMP	⇒ View the saved ".bmp" files.



Creating a library of the configurations for each application is recommended if the detector is used for more than one application.
Any SD card on the market can be used except cards with High Capacity technology, regardless of the memory size. Before use, make sure that the SD card is not locked (message "SD card not detected" displayed).



7.8.15 Service

Access to the Service menu is password protected. Reserved for the Service Centres.



8 Maintenance / replacement



NOTICE

Disclaimer of liability

Pfeiffer Vacuum accepts no liability for personal injury or material damage, losses or operating malfunctions due to improperly performed maintenance. The liability and warranty entitlement expires.

8.1 Maintenance intervals and responsibilities

The detector maintenance operations are described in the *Maintenance instructions* for the detector.

The manual specifies:

- maintenance intervals
- maintenance instructions
- shutting the product down
- tools and spare parts.

The maintenance manual is available on www.pfeiffer-vacuum.com and on the *CDRom of the detector's operating manual*.

9 Service

Pfeiffer Vacuum offers first-class customer service!

- On-Site maintenance for many products
- Overhaul/repair at the nearby Service Location
- Fast replacement with refurbished exchange products in mint condition
- Advice on the most cost-efficient and quickest solution

Detailed information, addresses and forms at: www.pfeiffer-vacuum.com (Service).

Overhaul and repair at the Pfeiffer Vacuum Service Center

The following general recommendations will ensure a fast, smooth servicing process:

- Fill out the "Service Request/Product Return" form and send it to your local Pfeiffer Vacuum Service contact.
- Include the confirmation on the service request from Pfeiffer Vacuum with your shipment.
- Fill out the declaration of contamination and include it in the shipment (mandatory!). The Declaration of contamination is valid for any product/device including a part exposed to vacuum.
- Dismantle all accessories and keep them.
- Close all the flange opening ports by using the original protective covers or metallic airtight blank flanges for contaminated devices.
- If possible, send the pump or unit in its original packaging.

Sending contaminated pumps or devices

No devices will be accepted if they are contaminated with micro-biological, explosive, or radioactive substances. "Hazardous substances" are substances and compounds in accordance with the hazardous goods regulations (current version).

- Neutralize the pump by flushing it with nitrogen or dry air.
- Close all openings airtight.
- Seal the pump or device in suitable protective film.
- Return the pump/device only in a suitable and sturdy transport container and send it in while following applicable transport conditions.

Pump or device returned without declaration of contamination form fully completed and/or not secured in suitable packaging will be decontaminated and/or returned at the shipper's expense.

Exchange or repair

The factory operating parameters are always pre-set with exchange or repaired devices. If you use specific parameters for your application, you have to set these again.

Service orders

All service orders are carried out exclusively according to our general terms and conditions for the repair and maintenance, available on our website.



10 Accessories

Description	Order number
Standard remote control (mbar·l/s)	106688
Standard remote control (Torr·l/s)	108881
Standard remote control (Pa·m ³ /s)	108880
Standard remote control (Pa·m ³ /s + Japon)	106690
RC 500 WL remote control	PT 445 432 -T
Standard Sniffer Probe	see Pfeiffer Vacuum catalog
Sniffer probe extension (10 m)	090216
Smart Sniffer Probe (3 m)	BG 449 207 -T
Smart Sniffer Probe (5 m)	BG 449 208 -T
Smart Sniffer Probe (10 m)	BG 449 209 -T
Helium 4 calibrated leak	see Pfeiffer Vacuum catalog
Adaptor for external calibrated leak DN 25 ISO-KF	110716
Spray gun (Elite)	109951
Spray gun (Standard)	112535
37 pin I/O board - Standard	121350S
37 pin I/O board - Wi-Fi	121351S
37 pin I/O board - Ethernet	121352S
Bypass kit (37 pin I/O board requested)	PT 445 411 -T (Europe) + PT 445 413 -T (US)
Bluetooth internal	123264
Exhaust connector for external OME - DN 25 ISO-KF (Wet Model)	122405
37 pin D-Sub/25 pin D-Sub adaptor cable	A333758
20 µm inlet filter, DN 25/25 ISO-KF	105841
5 µm inlet filter, DN 25/25 ISO-KF	105844
HLT I/O compatibility module	122742
Profibus	122253
Cart (*)	122570
Gauge cables	
3 m	A333746
10 m	A333747
20 m	A333748

* Integrable Model : external pumping cannot be installed on this type of trolley.

11 Technical data and dimensions

11.1 General

Databases of the leak detectors' technical characteristics Pfeiffer Vacuum:

- Technical characteristics according to:
 - AVS 2.3: Procedure for calibrating gas analyzers of the mass spectrometer type.
 - EN 1518: Non-destructive testing. Leak testing. Characterization of mass spectrometer leak detectors.
 - ISO 3530: Methods of calibrating leak-detectors of the mass-spectrometer-type used in the field of vacuum technology.
- Zero function or background suppression activated, in standard conditions (20 °C, 5 ppm ⁴He ambient, degassed detector).
- Acoustic pressure level: distance in relation to the detector 1 m.

11.2 Technical data

Parameter	ASM 340 Wet Model	ASM 340 Dry Model	ASM 340 Integrable Model
Flange (in)	DN 25 ISO-KF	DN 25 ISO-KF	DN 25 ISO-KF
Pumping speed for He	2.5 l/s	2.5 l/s	2.5 l/s
Backing pump capacity	15 m ³ /h	3.4 m ³ /h	According to primary pumping of the customer
Start-up time (20°C) without calibration	~ 3 min	~ 3 min	/
Noise level	54 dB (A)	52 dB (A)	54 dB (A)
Protection category	IP 20	IP 20	
Power consumption max.	850 W	600 W	350 W
Operating temperature (hard vacuum test)	0-45 °C	0-35 °C	0-45 °C ⁽¹⁾
Operating temperature (sniffing test)	0-35 °C	0-35 °C	0-40 °C
Maximum inlet test pressure	25 hPa	25 hPa	25 hPa (2)
Weight	56 kg	45 kg	32 kg
Detectable gases	⁴ He, ³ He, H ₂	⁴ He, ³ He, H ₂	⁴ He, ³ He, H ₂
Test method	Vacuum & sniffing leak detection	Vacuum & sniffing leak detection	Vacuum & sniffing leak detection
Minimum detectable leak rate for helium (sniffing leak detection)	5 · 10 ⁻¹⁰ Pa m ³ /s	5 · 10 ⁻¹⁰ Pa m ³ /s	5 · 10 ⁻¹⁰ Pa m ³ /s
Minimum detectable leak rate for helium (vacuum leak detection)	5 · 10 ⁻¹³ Pa m ³ /s	5 · 10 ⁻¹³ Pa m ³ /s	5 · 10 ⁻¹³ Pa m ³ /s
Supply	90-110 V, 50/60 Hz 110-130 V, 50/60 Hz 200-240 V, 50/60 Hz	90-240 V, 50/60 Hz	90-240 V, 50/60 Hz

Environmental conditions

Storage temperature	- 20 °C to + 55 °C
Maximum humidity of air	85%, without condensing
Maximum magnetic field	3 mT

¹ If primary pump limit vacuum < 5 · 10⁻² hPa. If not, +0 °C to +40 °C.

² Between 25 mbar and 5 mbar, qualitative measurement only.

11.3 Units of measurement

Conversion table: pressure units

	mbar	bar	Pa	hPa	kPa	Torr mm Hg
mbar	1	1 · 10 ⁻³	100	1	0.1	0.75
bar	1000	1	1 · 10 ⁵	1000	100	750
Pa	0.01	1 · 10 ⁻⁵	1	0.01	1 · 10 ⁻³	7.5 · 10 ⁻³
hPa	1	1 · 10 ⁻³	100	1	0.1	0.75
kPa	10	0.01	1000	10	1	7.5



	mbar	bar	Pa	hPa	kPa	Torr mm Hg
Torr mm Hg	1.33	$1.33 \cdot 10^{-3}$	133.32	1.33	0.133	1

$1 \text{ Pa} = 1 \text{ N/m}^2$

Conversion table: gas throughput units

	mbar·l/s	Pa·m ³ /s	sccm	Torr·l/s	atm·cm ³ /s
mbar·l/s	1	0.1	59.2	0.75	0.987
Pa·m ³ /s	10	1	592	7.5	9.87
sccm	$1.69 \cdot 10^{-2}$	$1.69 \cdot 10^{-3}$	1	$1.27 \cdot 10^{-2}$	$1.67 \cdot 10^{-2}$
Torr·l/s	1.33	0.133	78.9	1	1.32
atm·cm ³ /s	1.01	0.101	59.8	0.76	1

11.4 Dimensions

Wet & Dry Models

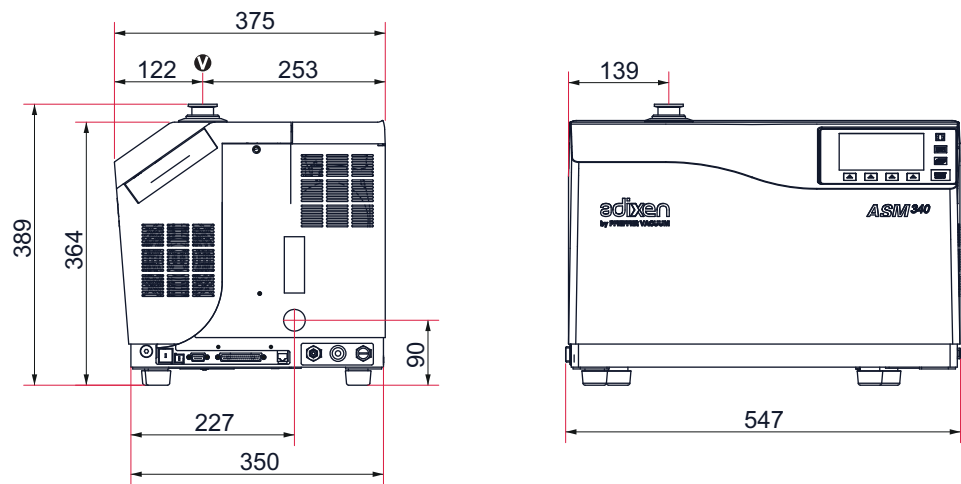

Integrable Model

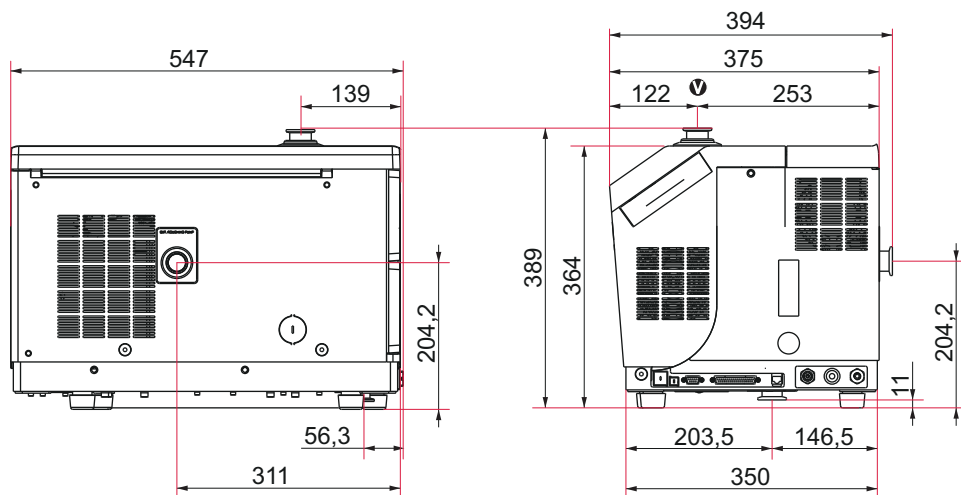



Declaration of conformity

We hereby declare that the product cited below satisfies all relevant provisions according to the following **EC directives**:

- **Machinery 2006/42/EC (Annex II, no. 1 A)**
- **Electromagnetic Compatibility 2014/30/EU**
- **Restriction of the use of certain Hazardous Substances 2011/65/EU**
- **Waste of Electrical and Electronic Equipment 2012/19/EEC**

The technical file is drawn up by Mr Arnaud Favre, Pfeiffer Vacuum SAS, [simplified joint stock company], 98, avenue de Brogny · B.P. 2069, 74009 Annecy cedex.

ASM 340 Wet and Dry

Harmonised standards and national standards and specifications which have been applied:

Standards NF EN-61000-6-2 : 2005

Standards NF EN-61000-6-3 : 2007

Standards NF EN-61000-6-4 : 2007

Standards NF ENV-50204 : 1996

Standards NF EN-60204-1 : 2006

Signatures:

Pfeiffer Vacuum SAS
98, avenue de Brogny
B.P. 2069
74009 Annecy cedex
France

(M. Taberlet)
President

(M. Favre)
Research and Development Director

12.06.2017





Declaration of incorporation of partly completed machinery

We hereby declare that the product cited below satisfies all relevant provisions according to the following **EC directives**:

- **Machines 2006/42/CE (Annexe II, No. 1 A)**
- **Compatibilité électromagnétique 2014/30/UE**

This partly completed machinery must not be put into operation until the machinery into which it is to be incorporated has been declared in conformity with the provisions of the **2006/42/EC Directive**.

We, authorized representatives undertake to transmit, in response to a reasoned request by national authorities, relevant information on the partly completed machinery.

The technical file is drawn up by Mr Arnaud Favre, Pfeiffer Vacuum SAS, [simplified joint stock company], 98, avenue de Brogny · B.P. 2069, 74009 Annecy cedex.

ASM 340 Integrable

Harmonised standards and national standards and specifications which have been applied:

Standards NF EN-61000-6-2 : 2005

Standards NF ENV-50204 : 1996

Standards NF EN-61000-6-3 : 2007

Standards NF EN-60204-1 : 2006

Standards NF EN-61000-6-4 : 2007

Signatures:

Pfeiffer Vacuum SAS
98, avenue de Brogny
B.P. 2069
74009 Annecy cedex
France

(M. Taberlet)
President

(M. Favre)
Research and Development Director

12.06.2017



VACUUM SOLUTIONS FROM A SINGLE SOURCE

Pfeiffer Vacuum stands for innovative and custom vacuum solutions worldwide, technological perfection, competent advice and reliable service.

COMPLETE RANGE OF PRODUCTS

From a single component to complex systems:

We are the only supplier of vacuum technology that provides a complete product portfolio.

COMPETENCE IN THEORY AND PRACTICE

Benefit from our know-how and our portfolio of training opportunities!

We support you with your plant layout and provide first-class on-site service worldwide.

Ed05- Date 2017/06 - P/N: 1217620EN



Are you looking for a
perfect vacuum solution?
Please contact us:

Pfeiffer Vacuum GmbH
Headquarters • Germany
T +49 6441 802-0
info@pfeiffer-vacuum.de

www.pfeiffer-vacuum.com

PFEIFFER  **VACUUM**



蒙天真空
MT VACUUM